

W.P.S. Cames van Batenburg

Almost sure bounds for the mass dimension and discrete Hausdorff dimension of the Incipient Infinite Cluster

Master thesis, defended on December 13, 2013

Thesis advisor: Dr. M.O. Heydenreich

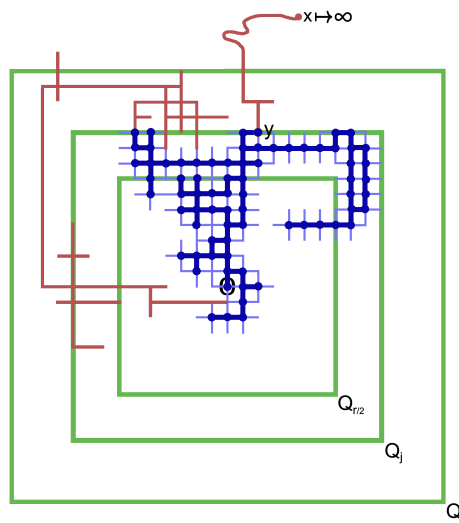

Mathematisch Instituut, Universiteit Leiden

Contents

1	Introduction	2
1.1	Bond percolation on \mathbb{Z}^d	2
1.2	Some notation, the BK-inequality and the two-point function	3
1.3	The Incipient Infinite Cluster	4
1.4	Dimensions	5
1.5	Some relevant random sets and quantities we want to calculate	6
1.6	Markov's inequality and Borel-Cantelli	6
1.7	Results	7
1.8	Motivation for Conjecture 1.12	10
1.9	Approaches that didn't work	11
1.10	Closing remark	12
2	Technical lemmas, tree diagrams and moment bounds	13
2.1	Technical lemmas, convolution and bounding small diagrams	13
2.2	Bounding expectation values by bounding tree diagrams	19
2.3	Relatively intuitive and readable proof that $\mathbb{E}_{IIC}(X_r ^2) \leq C \cdot r^2$	27
3	Using moment bounds	29
3.1	Using moment bounds, Markov's inequality and Borel-Cantelli for bounds on the (upper mass) dimension	29
3.2	Lower bounds on the mass dimension of the IIC, using conjectured moment bounds	31
4	Positive probability lemma	38
4.1	For all r it holds that $ X_r $ is of order r^4 with probability bounded away from 0	38
4.2	Adapted Borel 0-1 law for almost independent events	38
5	Discrete Hausdorff dimension	41
5.1	Definition Hausdorff dimensions	41
5.2	Discrete energy method	43
5.3	Almost sure lower bounds for the discrete Hausdorff dimension of a random set $A \subset \mathbb{Z}^d$	44
5.4	Conditional proof of the discrete Hausdorff dimension of the IIC	46
6	Lower bound on $X_{r,r}$	48

1 Introduction

In this thesis we study nearest neighbour bond percolation on \mathbb{Z}^d in high dimensions and at the critical threshold $p = p_c$, conditioned -loosely speaking- on the event that the connected component containing 0 is infinitely large. This component is called the *Incipient Infinite Cluster (IIC)*. The main goal is to bound the (upper, lower) mass dimension of the IIC. We obtain that it almost surely holds that the lower mass dimension of the IIC is ≥ 3 and the upper mass dimension of the IIC is ≤ 4 . Furthermore, we introduce a discrete Hausdorff dimension (*dHd*) and give sufficient conditions for the *dHd* of the IIC to be 4. Along the way we also bound dimensions of other random sets like the backbone (mass dimension ≤ 2) and we present a conditional proof for a sharp almost sure lower bound on the mass dimension of the IIC, based on a conjecture on certain moment bounds.

1.1 Bond percolation on \mathbb{Z}^d

Let $|x|_e$ denote the Euclidean norm of $x \in \mathbb{Z}^d$. Consider the infinite graph with vertex set \mathbb{Z}^d and set of edges (or bonds) $E = \{(x, y) \mid x, y \in \mathbb{Z}^d \text{ and } |x - y|_e = 1\}$. We study bond percolation on this graph. That is, we fix $p \in [0, 1]$ and then each edge $e \in E$ is declared *open* (1) with probability p and *closed* (0) otherwise, independently of all other edges. The resulting random subgraph of open edges has many interesting theoretical properties, but it can also be used to model a variety of physical phenomena, like transport in porous materials, the electrical properties of ionic conductors or the spread of forest fires and diseases [1]. Formally, the associated probability space $(\Omega, \mathcal{F}, \mathbb{P}_p)$ has sample space $\Omega = \prod_{e \in E} \{0, 1\}$, the σ -field \mathcal{F} is generated by the finite-dimensional cylinder sets and the probability measure is the product measure $\mathbb{P}_p = \prod_{e \in E} \mu_p$, where $\mu_p(1) = p, \mu_p(0) = 1 - p$. The expectation w.r.t. \mathbb{P}_p is denoted by \mathbb{E}_p . Although we will restrict ourselves to *nearest neighbour* percolation, as described above, it is to be expected that many results in this thesis can be generalized in a rather straightforward way to *finite-range spread-out* percolation and *long-range spread-out* percolation [2], which are examples of bond percolation on \mathbb{Z}^d where additional bonds (x, y) with $|x - y|_e > 1$ are open with a positive probability that is decreasing in $|x - y|_e$.

Let $\{x \leftrightarrow y\}$ denote the event that the vertices x and y are connected by a path of open edges. The *connected component* or *open cluster* of $x \in \mathbb{Z}^d$ is defined by $\mathcal{C}(x) := \{y \in \mathbb{Z}^d \mid x \leftrightarrow y\}$. It is well known [3] that percolation undergoes a phase transition at the critical threshold

$$p_c := \inf \{p \mid \theta(p) > 0\}$$

where $\theta(p) := \mathbb{P}_p(|\mathcal{C}(0)| = \infty)$. In our context [4] an equivalent definition of p_c is:

$$p_c = \sup \{p \mid \chi(p) < \infty\}$$

where

$$\chi(p) := \sum_{x \in \mathbb{Z}^d} \mathbb{P}_p(0 \leftrightarrow x) = \mathbb{E}_p(|\mathcal{C}(0)|)$$

is the *expected cluster size*. In words: if $p < p_c$ then the cluster of 0 is almost surely finite. If $p > p_c$ this is no longer the case; in particular the expected value of the cluster of 0 has become infinite. What happens at $p = p_c$ is enigmatic ([3], [1]). It is known that $\theta(p_c) = 0$ for the case $d = 2$ (by a duality argument) and for $d \geq 19$ (follows from a lace expansion). One of the central conjectures in percolation theory is that this is true too for all $d \geq 2$. Another nice property of p_c , illustrating the term ‘phase transition’, is that at p_c the probability of the existence of an infinite open cluster dramatically jumps from 0 to 1:

$$\mathbb{P}(\exists x \in \mathbb{Z}^d \text{ s.t. } |\mathcal{C}(x)| = \infty) = \begin{cases} 0 & \text{if } p < p_c \\ 1 & \text{if } p > p_c \end{cases}.$$

Furthermore, if $\theta(p) > 0$ then $\mathbb{P}_p(\text{there is exactly one infinite open cluster}) = 1$. Finally we remark that calculating p_c is a nontrivial problem for $d \geq 2$; so far this has only been possible for $d = 2$, in which case duality arguments show that $p_c = 1/2$. One could argue that this calculation has been possible because the value $1/2$ is ‘easy’.

Understanding percolation at $p = p_c$ becomes less complicated in ‘high’ dimensions d , because then the clusters obtain tree-like properties; the probability of large cycles of open edges becomes very small, so a cluster in the percolated graph will resemble a connected graph without cycles: a tree. As a consequence, percolation on \mathbb{Z}^d with high d behaves in many ways like percolation on an infinite tree. An explicit notion of high-dimensionality is given by the *triangle condition*, which is satisfied if the following *triangle diagram*

$$\sum_{x,y \in \mathbb{Z}^d} \mathbb{P}_p(0 \leftrightarrow x) \cdot \mathbb{P}_p(x \leftrightarrow y) \cdot \mathbb{P}_p(y \leftrightarrow 0) \quad (1.1)$$

is finite for all $p \leq p_c$. The triangle condition is believed to be satisfied whenever $d > 6$, but so far it has only been proved to hold for $d \geq 19$ and only recently for $d \geq 15$, in case of nearest neighbour percolation [5], [6]. For finite-range spread-out percolation, provided the spread-out parameter is chosen large enough, there *does* exist a proof that the triangle condition holds for all $d > 6$ [7].

1.2 Some notation, the BK-inequality and the two-point function

The volume of a subset $A \subset \mathbb{Z}^d$ is denoted by $|A| := \#\{x \in A\}$, but for a vertex $x \in \mathbb{Z}^d$ we let $|x|$ denote the supremum norm of x . The choice for this particular norm is not essential, as all norms on \mathbb{R}^d are equivalent and almost all estimates in this thesis hold up to a constant multiple, but is taken fixed to avoid confusion and because of the useful property that $|x| \in \mathbb{N}$ for all $x \in \mathbb{Z}^d$.

For $x \in \mathbb{Z}^d$ and $r \in \mathbb{N}$ the *ball with centre x and radius r* is the following vertex set

$$Q_r(x) := \{y \in \mathbb{Z}^d \text{ such that } |x - y| \leq r\}.$$

Its *boundary* is

$$\partial Q_r(x) := \{y \in \mathbb{Z}^d \text{ such that } |x - y| = r\}.$$

In case $x = 0$ we just write $Q_r(0) = Q_r$ and $\partial Q_r(0) = \partial Q_r$.

For a configuration ω in the sample space $\Omega = \{0, 1\}^E$ and a bond $e \in E$ we write $\omega(e) = 0$ if e is closed and $\omega(e) = 1$ if e is open. An event $A \subset \Omega$ is called *increasing* if for any two configurations $\omega_1, \omega_2 \in \Omega$ that satisfy $\omega_1(e) \leq \omega_2(e)$ for all $e \in E$, it holds that $(\omega_1 \in A) \Rightarrow (\omega_2 \in A)$. An example of an increasing event is $\{0 \leftrightarrow x\}$. Indeed: if $\omega_1 \in \{0 \leftrightarrow x\}$ and $\omega_1 \leq \omega_2$ then all bonds that are open in ω_1 are also open in ω_2 , so any open path in ω_1 also exists in ω_2 , so $\omega_2 \in \{0 \leftrightarrow x\}$.

Let $A, B \subset \Omega$. Then the event that A and B occur on disjoint sets (or: *occur disjointly*) is given by

$$A \circ B := \{\omega \in \Omega \mid \text{there exists } F \subset E \text{ such that } \omega_F \in A \text{ and } \omega_{E \setminus F} \in B\},$$

where for any configuration $\omega \in \Omega$ and any edge subset $F \subset E$:

$$\omega_F(e) := \begin{cases} \omega(e) & \text{for } e \in F \\ 0 & \text{for } e \notin F. \end{cases}$$

Example: the (increasing) event $\{0 \leftrightarrow x\} \circ \{0 \leftrightarrow y\}$ occurs iff there exist two open paths that don’t share an open bond, one of which connects x to 0, while the other connects y to 0.

The *Van den Berg-Kesten inequality* [3], commonly referred to as the BK-inequality, states that for any two increasing events A and B :

$$\mathbb{P}_p(A \circ B) \leq \mathbb{P}_p(A) \cdot \mathbb{P}_p(B). \quad (1.2)$$

Often we will bound the probability of a complicated event by the probability of disjoint occurrence of other events, which in turn can be bounded above using the BK-inequality.

For nonnegative functions $f(t), g(t)$ we write $f(t) \asymp g(t)$ to denote that $c \cdot g(t) \leq f(t) \leq C \cdot g(t)$ holds asymptotically for some constants $c, C > 0$. Typically these constants are not optimized and therefore the symbols c and C will often be used for different constants, even within a single proof.

For $x, y \in \mathbb{Z}^d$ we define the *two-point function*

$$\tau(x - y) := \mathbb{P}_{p_c}(x \leftrightarrow y).$$

For nearest neighbour percolation in dimension $d \geq 19$ (and for finite-range spread-out percolation in dimension $d > 6$) a strong result on the asymptotics of $\tau(x)$ is proved in [8],[9]. We will only need its implication that for those dimensions:

$$\tau(x - y) \asymp |x - y|^{d-2}. \quad (1.3)$$

It can be shown that (1.3) implies that the triangle condition (1.1) holds and, just as with the triangle condition, it is widely believed that (1.3) is actually true for all $d > 6$. From now on we will assume that our model is *high-dimensional*, by which we mean that (1.3) is satisfied!

1.3 The Incipient Infinite Cluster

In this thesis we focus on high-dimensional nearest neighbour percolation and we zoom in on what happens at the phase transition. More specifically: we consider percolation at $p = p_c$ and condition on some event E_n that, as $n \rightarrow \infty$, implies that $\mathcal{C}(0)$ is infinitely large. This conditioning can be done in several ways. For example: one can condition on the event $\{0 \leftrightarrow x\}$ and let $|x| \rightarrow \infty$. Recall that as we let p increase from p_c to a value $> p_c$, the probability that $|\mathcal{C}(0)| = \infty$ goes from 0 to a positive value. Also, for $d \geq 19$ and percolation at $p = p_c$ it has been shown that there are typically some very large but finite clusters near the origin (see [10] for a precise statement). Therefore, by looking at $p = p_c$ and ‘conditioning on the event that $\mathcal{C}(0)$ is infinitely large’, we can study $\mathcal{C}(0)$ at the point where it is just becoming infinitely large (with positive probability). Hence we call $\mathcal{C}(0)$ the Incipient Infinite Cluster (IIC) in this context. ‘Conditioning on the event that $\mathcal{C}(0)$ is infinitely large’ typically induces a probability measure, which will be referred to as an (or the) IIC-measure. Several different but equivalent ways of constructing IIC-measures have been found.

Here we describe three constructions of an IIC-measure. Denote by \mathcal{F}_0 the algebra of *cylinder events* (i.e.: events that are determined by finitely many bonds) and by \mathcal{F} the σ -algebra of *events*, generated by \mathcal{F}_0 . The first construction is

$$\mathbb{P}_{IIC}(F) = \lim_{|x| \rightarrow \infty} \mathbb{P}_{p_c}(F \mid 0 \leftrightarrow x), \text{ for } F \in \mathcal{F}_0 \quad (1.4)$$

whenever the limit exists. The second construction is

$$\mathbb{Q}_{IIC}(F) = \lim_{p \uparrow p_c} \frac{1}{\chi(p)} \sum_{x \in \mathbb{Z}^d} \mathbb{P}_p(F \cap \{0 \leftrightarrow x\}), \text{ for } F \in \mathcal{F}_0 \quad (1.5)$$

whenever the limit exists. The third construction is

$$\mathbb{R}_{IIC}(F) = \lim_{r \rightarrow \infty} \mathbb{P}_{p_c}(F \mid 0 \leftrightarrow \partial Q_r), \text{ for } F \in \mathcal{F}_0$$

whenever the limit exists.

In [11] Van der Hofstad and Járai proved, under assumption that (1.3) holds true, that the measures \mathbb{P}_{IIC} and \mathbb{Q}_{IIC} exist and are equivalent. That is, the limits $\mathbb{P}_{IIC}(F)$ and $\mathbb{Q}_{IIC}(F)$ exist and are equal for all cylinder events F ; consequently \mathbb{P}_{IIC} and \mathbb{Q}_{IIC} can be extended to the σ -algebra of events $\sigma(\mathcal{F}_0) = \mathcal{F}$ and $\mathbb{P}_{IIC}(F) = \mathbb{Q}_{IIC}(F)$ for all $F \in \mathcal{F}$. Note however that this does not mean that we can also evaluate *any* $F \in \mathcal{F} \setminus \mathcal{F}_0$ in (1.4) or (1.5) to calculate $\mathbb{P}_{IIC}(F)$! The event $F = \{0 \leftrightarrow x\}$ is an exception; it is not a cylinder event, but it has been shown in [11] that (1.4) nevertheless does hold for this event. Another ‘exception’ is provided by the so called *Backbone limit reversal lemma* [2], which we will not use in this thesis. It roughly says that the probability of any event occurring on (a certain random subset of) the *backbone* (see Definition 1.5) of the IIC may be calculated using almost the same construction as (1.5).

Kozma and Nachmias [12] proved that for high-dimensional percolation, under assumption that (1.3) holds, we have that

$$\mathbb{P}_{p_c}(0 \leftrightarrow \partial Q_r) \asymp r^{-2} \quad (1.6)$$

and in [2] it is proved that if $\mathbb{P}_{p_c}(0 \leftrightarrow \partial Q_r) \asymp r^{-2}$, then there exists an increasing subsequence r_n such that the limit $R_{IIC}(F) = \lim_{n \rightarrow \infty} \mathbb{P}_{p_c}(F | 0 \leftrightarrow \partial Q_{r_n})$ exists for any cylinder event F . Furthermore, if the measures \mathbb{P}_{IIC} , \mathbb{Q}_{IIC} and \mathbb{R}_{IIC} exist, then they are equal.

In this thesis we will actually only make use of the constructions \mathbb{P}_{IIC} and \mathbb{Q}_{IIC} . Since they are equivalent in our context (being that d is such that (1.3) holds) we will from now on refer to both constructions as \mathbb{P}_{IIC} . Furthermore, \mathbb{E}_{IIC} will denote expectation with respect to \mathbb{P}_{IIC} .

1.4 Dimensions

Having introduced the IIC probability measures, we now want to determine some properties of the IIC. A natural question is: how large is the IIC? By construction we already know that it (\mathbb{P}_{IIC} -almost surely) is infinitely large, so we cannot simply count all vertices in $\mathcal{C}(0)$ to sensibly determine how large it is. Instead we will try to calculate ‘the’ dimension of the IIC. There is not just one canonical way of defining the dimension of a subset of \mathbb{Z}^d . In what follows we introduce several concepts of dimension and some random subsets of \mathbb{Z}^d of which we would want to calculate a dimension.

Definition 1.1

The **mass dimension** of a subset $A \subset \mathbb{Z}^d$ is defined as

$$d_m(A) := \lim_{r \rightarrow \infty} \frac{\log |A \cap Q_r|}{\log(r)}$$

if the limit exists. The upper mass dimension of A is

$$\overline{d}_m(A) := \limsup_{r \rightarrow \infty} \frac{\log |A \cap Q_r|}{\log(r)}$$

and the lower mass dimension of A is

$$\underline{d}_m(A) := \liminf_{r \rightarrow \infty} \frac{\log |A \cap Q_r|}{\log(r)}.$$

Definition 1.2

The **volume growth exponent** of an infinite connected graph G is defined as

$$d_f(G) := \lim_{r \rightarrow \infty} \frac{\log |B_G(x, r)|}{\log(r)},$$

if the limit exists. Here $B_G(x, r)$ is the ball, in the shortest-path metric, with center x and radius r and $|B_G(x, r)|$ is its volume. The upper volume growth exponent of G is $\overline{d}_f(G) := \limsup_{r \rightarrow \infty} \frac{\log |B_G(x, r)|}{\log(r)}$.

Definition 1.3

The **spectral dimension** of an infinite connected graph G is defined as

$$d_s(G) := -2 \lim_{r \rightarrow \infty} \frac{\log p_{2r}(x)}{\log(r)},$$

where $p_{2r}(x)$ is the return probability of the simple random walk on G after r steps. If the limit exists then d_s is independent of the starting point $x \in G$.

The dimensions introduced above don’t necessarily exist, because of the limits involved. In section 5 we will introduce the **discrete Hausdorff dimension** $d_{\mathcal{H}, \epsilon(r)}(A)$ of a subset $A \subset \mathbb{Z}^d$ with respect to a function $\epsilon(r)$, which *does* exist for all A . See Definition 5.3. This thesis focuses on the mass dimension and the discrete Hausdorff dimension.

1.5 Some relevant random sets and quantities we want to calculate

Recall that in the context of the IIC-measure we have that $\mathcal{C}(0)$ is infinite and we sometimes write $IIC := \mathcal{C}(0)$. Let $A \subset \mathbb{Z}^d$ be a set and let $x, y \in A$, then $\{x \xleftrightarrow{A} y\}$ denotes the event that x and y are connected by a path of open edges of which the adjacent vertices are all in A .

Definition 1.4

The following is the most central quantity in this thesis, because (moment) estimates on it provide information on the mass dimension of the IIC:

$$X_r := IIC \cap Q_r = \{x \in Q_r \mid 0 \leftrightarrow x\}.$$

In section 6 we will also study

$$X_{r,R} := \{x \in Q_r \mid 0 \xleftrightarrow{Q_R} x\}$$

to find a lower bound on $|X_r|$, because $|X_{r,R}| \leq |X_r|$ for all $R \in \mathbb{N}$.

Because there is an open path from 0 to infinity in IIC, the following definitions make sense.

Definition 1.5

The edge backbone of the IIC is defined as

$$Bb := \{ \text{'directed' edges } (b, \bar{b}) \text{ such that } \{0 \leftrightarrow b\} \circ \{\bar{b} \leftrightarrow \infty\} \text{ and } b \text{ is open} \}$$

The number of edges in the edge backbone at distance at most r from 0 is

$$|Bb_r| := \# \{ \text{'directed' edges } (b, \bar{b}) \text{ with } b \in \mathcal{C}(0) \cap Q_r \text{ such that } \{0 \leftrightarrow b\} \circ \{\bar{b} \leftrightarrow \infty\} \text{ and } b \text{ is open} \}$$

On the other hand, the vertex backbone of the IIC is defined as

$$Bb^* := \{x \in \mathbb{Z}^d \mid \{0 \leftrightarrow x\} \circ \{x \leftrightarrow \infty\}\}$$

and

$$Bb_r^* := \{x \in Q_r \mid \{0 \leftrightarrow x\} \circ \{x \leftrightarrow \infty\}\}.$$

Usually the term *backbone* refers to the edge backbone, but our dimensions are defined for subsets of \mathbb{Z}^d . Note however that $|Bb_r| \asymp |Bb_r^*|$, so asymptotic estimates on $|Bb_r|$ from literature will also hold for $|Bb_r^*|$, up to a constant value, allowing us to estimate the dimension of $Bb^* \subset \mathbb{Z}^d$.

1.6 Markov's inequality and Borel-Cantelli

The following are standard results from literature. We will use them in particular to derive the bounds of Theorem 1.10, stated below. In the proof of that theorem, Markov's inequality produces an initial bound on the probability of an event and subsequently Borel-Cantelli transforms it into an almost sure statement.

Lemma 1.6 (Markov's inequality [17])

Let X be a non-negative random variable with finite expectation, then it holds for all $a > 0$ that

$$\mathbb{P}(X \geq a) \leq \frac{\mathbb{E}(X)}{a}.$$

Lemma 1.7 (Borel-Cantelli [17])

Let $(A_n)_{n \geq 1}$ be a sequence of events in a probability space. If

$$\sum_{n=1}^{\infty} \mathbb{P}(A_n) < \infty$$

then

$$\mathbb{P}(A_n \text{ i.o.}) = 0,$$

where by definition:

$$\{A_n \text{ i.o.}\} = \limsup_{n \rightarrow \infty} A_n = \bigcap_{i=0}^{\infty} \bigcup_{n=i}^{\infty} A_n$$

is the event that A_n occurs infinitely often (i.o.), that is: for infinitely many n .

1.7 Results

We start out with some known results, for comparison, and from there work to the contributions of this thesis. Recall that we implicitly assume that our model is high-dimensional.

Theorem 1.8 ([13])

$$\mathbb{P}_{IIC} \left(d_s(IIC) = \frac{4}{3} \right) = 1. \quad (1.7)$$

Proof. This is part of the statement of Theorem 1.1 in [13]. \square

Theorem 1.9 ([2], [13])

There exist constants $c, C > 0$ such that for all $r > 0$:

$$c \cdot r \leq \mathbb{E}_{p_c} (|B_{\mathcal{C}(0)}(0, r)|) \leq C \cdot r. \quad (1.8)$$

$$c \cdot r^2 \leq \mathbb{E}_{p_c} (|X_r|) \leq C \cdot r^2. \quad (1.9)$$

$$c \cdot r^4 \leq \mathbb{E}_{IIC} (|X_r|) \leq C \cdot r^4. \quad (1.10)$$

$$c \cdot r^2 \leq \mathbb{E}_{IIC} (|Bb_r|) \leq C \cdot r^2. \quad (1.11)$$

Proof. (1.8) follows from Theorem 1.2 and 1.3 in [13]. Claims (1.9), (1.10) and (1.11) are the subject of Theorem 1.5 in [2]. \square

A common property of $|B_{\mathcal{C}(0)}(0, r)|$, $|X_r|$ and $|Bb_r^*|$ is that they are nondecreasing in r . We will prove (see Theorem 1.10.i) that this property allows us to transform the upper bounds on the expectation values in a.s. statements on upper dimensions.

Theorem 1.10

Let Z_1, Z_2, \dots be a sequence of random variables with values in $\mathbb{R}_{>0}$, such that $Z_1 \leq Z_2 \leq \dots$

(i) If there exist constants $\beta, C > 0$ such that at least one of the following two conditions holds

- $\mathbb{E}(Z_r) \leq C \cdot r^\beta$ for all $r > 0$.
- $\mathbb{P}(Z_r \geq \lambda \cdot r^\beta) \leq C \cdot \frac{1}{\lambda}$ for all $\lambda, r > 0$.

Then:

$$\mathbb{P} \left(\limsup_{r \rightarrow \infty} (\log_r(Z_r)) \leq \beta \right) = 1. \quad (1.12)$$

(ii) If there exist constants $\alpha, C' > 0$ such that at least one of the following two conditions holds

- $\mathbb{E} \left(\frac{1}{Z_r} \right) \leq C' \cdot r^{-\alpha}$ for all $r > 0$.
- $\mathbb{P}(Z_r \leq \frac{1}{\lambda} \cdot r^\alpha) \leq C' \cdot \frac{1}{\lambda}$ for all $\lambda, r > 0$.

Then:

$$\mathbb{P} \left(\liminf_{r \rightarrow \infty} (\log_r(Z_r)) \geq \alpha \right) = 1. \quad (1.13)$$

Corollary 1.11

$$\mathbb{P}_{p_c}(\overline{d}_f(\mathcal{C}(0)) \leq 1) = 1 \quad (1.14)$$

$$\mathbb{P}_{p_c}(\overline{d}_m(\mathcal{C}(0)) \leq 2) = 1 \quad (1.15)$$

$$\mathbb{P}_{IIC}(\overline{d}_m(IIC) \leq 4) = 1 \quad (1.16)$$

$$\mathbb{P}_{IIC}(\overline{d}_m(Bb^*) \leq 2) = 1. \quad (1.17)$$

Proof. Apply Theorem 1.10.i to the upper bounds in Theorem 1.9. For the implication from (1.11) to (1.17) also use that $Bb_r \asymp Bb_r^*$. \square

Note that (1.14) and (1.15) are actually trivial: as $\mathcal{C}(0)$ is almost surely finite at $p = p_c$ we have that $\overline{d}_f(\mathcal{C}(0))$ and $\overline{d}_m(\mathcal{C}(0))$ both almost surely equal 0. Still, (1.14) illustrates that the applications of Theorem 1.10 are not limited to bounding the mass dimension of a random set. The bounds in (1.16) and (1.17) are believed to be sharp and as matter of fact this thesis is all about trying to prove it.

Conjecture 1.12

$$\mathbb{P}_{IIC}(d_m(IIC) = 4) = \mathbb{P}_{IIC}(d_m(Bb^*) = 2) = 1$$

and the same values hold \mathbb{P}_{IIC} -almost surely for the discrete Hausdorff dimension.

On first sight it may look like the lower bounds of the form $c \cdot r^\alpha \leq \mathbb{E}(Z_r)$ in Theorem 1.9 will provide the complementary statements on the lower dimensions that are necessary to prove the conjecture for the mass dimension, but this is not true. What we actually would need are, for example, statements of the form $\mathbb{E}(\frac{1}{Z_r}) \leq C \cdot r^{-\alpha}$, because then we can apply Theorem 1.10.ii to conclude that almost surely: $\liminf_{r \rightarrow \infty} (\log_r(Z_r)) \geq \alpha$. In fact, bounds of the form $c \cdot r^\alpha \leq \mathbb{E}(Z_r)$ (without any other knowledge) provide almost no information on lower dimensions, as the following example illustrates.

Example 1.13

Let $\epsilon > 0$. Let Z_1, Z_2, \dots be a sequence of random variables with values in $\mathbb{R}_{\geq 1}$ and let \mathbb{P} be any probability measure such that for all $r \in \mathbb{N}$ it holds that $\mathbb{P}(Z_r = r^\alpha \cdot \log(r)) = \frac{1}{\log(r)}$ and $\mathbb{P}(1 \leq Z_r < r^{\alpha-\epsilon}) = 1 - \frac{1}{\log(r)}$. Then there is a constant C such that for all r :

$$r^\alpha \leq \mathbb{E}(Z_r) \leq r^\alpha \log(r) \cdot \frac{1}{\log(r)} + r^{\alpha-\epsilon} \cdot \left(1 - \frac{1}{\log(r)}\right) \leq C \cdot r^\alpha.$$

But we have $\lim_{r \rightarrow \infty} \mathbb{P}(\log_r(Z_r) = \alpha) = 0$, so $\log_r(Z_r)$ does not converge in probability to α , so it certainly doesn't converge almost surely to α . In effect, we see that the existence of constants c, C such that $c \cdot r^\alpha \leq \mathbb{E}(Z_r) \leq C \cdot r^\alpha$ (without any other knowledge) implies almost nothing about the limit probability distribution of $\log_r(Z_r)$: a priori it could be any probability distribution on the interval $[0, \alpha]$!

So it turns out that bounding the mass dimension from below is quite a difficult task.

Using moments for a.s. lower bounds on the lower mass dimension of a random set

In Theorem 2.10 we perform a complicated computation of an expectation value, based on the technical results in section 2. An important corollary is that there exists a constant $C > 0$ such that for all $r, n \in \mathbb{N}$:

$$\mathbb{E}_{IIC}(|X_r|^n) \leq C \cdot \frac{(2n)!}{2^n \cdot n!} \cdot \mathbb{E}_{IIC}(|X_r|)^n. \quad (1.18)$$

We will use the case $n = 2$ to prove:

Theorem 1.14

There exists a constant $C > 0$ such that for all $\lambda \geq 1$ and all r :

$$\mathbb{P}_{IIC} \left(|X_r| \geq \frac{E_{IIC}(|X_r|)}{\lambda} \right) \geq C \cdot \left(1 - \frac{1}{\lambda} \right)^2.$$

The general case of inequality (1.18) provides us with intuition on the exact values of $\mathbb{E}_{IIC}(|X_r|^n)$. In subsection 3.2 we formulate and motivate a conjecture for these moments. Because the conjectured values for the moments $\left(\frac{(2n)!}{2^n \cdot n!}\right)$ turn out to grow very fast as a function of n , a method for bounding the lower mass dimension of a random subset of \mathbb{Z}^d is derived, based on a rather special function whose power series converges fast enough. In particular we apply this to the IIC-measure and the IIC itself to investigate conditions on the moments $\mathbb{E}_{IIC}(|X_r|^n)$ under which $\log_r(|X_r|)$ would converge in probability (Corollaries 3.7 and 3.8) or almost surely (Corollary 3.10) to 4.

Bounds on the discrete Hausdorff dimension of a random set

In section 5 we define the discrete Hausdorff dimension $d_{\mathcal{H}, \epsilon(r)}$ w.r.t a function $\epsilon(r)$ and we prove Lemma 5.4, which states that for all $A \subset \mathbb{Z}^d$:

$$d_{\mathcal{H}, \epsilon(r)}(A) \leq \overline{d}_m(A). \tag{1.19}$$

Furthermore, we derive a variant of the so called energy method to find an almost sure lower bound for the discrete Hausdorff dimension of any random subset of \mathbb{Z}^d : see Lemma 5.6 and Theorem 5.7. To find these lower bounds explicitly one ‘merely’ needs to calculate a certain expectation value. In particular we apply this to the IIC-measure: combining the energy method, Cauchy-Schwarz and an important corollary of the expectation value computation in Theorem 2.10, we obtain Corollary 5.13, which states that Conjecture 1.12 holds true for the IIC, *provided* that $\mathbb{E}_{IIC}(|X_r|^{-4}) \leq C \cdot \epsilon(r)^{-2\delta} r^{-16}$ holds for $\delta = 0$ or for all $\delta > 0$.

Volume growth exponent and lower mass dimension of the IIC

Based on (1.8), Markov’s inequality and their result that $c \cdot \frac{1}{r} \leq \mathbb{P}_{p_c}(\partial B_{\mathcal{E}(0)}(0, r) \neq \emptyset) \leq C \cdot \frac{1}{r}$, Kozma and Nachmias proved [13] that there exists a $C > 0$ such that for fixed $r \geq 1$ it holds for all $x \in \mathbb{Z}^d$ with $|x|$ sufficiently large and all $\lambda > 1$ that: $\mathbb{P}_{p_c}(B_{IIC}(0, r) \geq \lambda \cdot r^2 |0 \leftrightarrow x) \leq C \cdot \frac{1}{\lambda}$ and $\mathbb{P}_{p_c}(B_{IIC}(0, r) \leq \frac{1}{\lambda} \cdot r^2 |0 \leftrightarrow x) \leq C \cdot \frac{1}{\lambda}$. Therefore we may apply Theorem 1.10 ((i) and (ii)) to conclude that the volume growth exponent of the IIC almost surely equals 2:

Theorem 1.15 (Kozma and Nachmias [13])

$$\mathbb{P}_{IIC}(d_f(IIC) = 2) = \mathbb{P}_{IIC} \left(\lim_{r \rightarrow \infty} \left(\frac{\log |B_{IIC}(0, r)|}{\log(r)} \right) = 2 \right) = 1.$$

Inspired by the techniques used by Kozma and Nachmias we derive Theorem 1.16. The reason why our bound is not yet as sharp as the result of Theorem 1.15 is, probably, that the nature of the ball $B_{IIC}(r)$ (with respect to the shortest-path metric in the random graph formed by the IIC) allows for finding certain nice *independent* events, while these events become dependent when translated to the ‘ball’ $IIC \cap Q_r$ (recall that Q_r is the ball with respect to the deterministic metric induced by the supremum norm). This dependency is caused by the fact that for a set $A \subset Q_r$ the event $\{A = IIC \cap Q_r\}$ may also depend on edges that are outside Q_r . We circumvent this problem by considering only points in Q_r that are connected to 0 by a path *within* Q_r , that is: we bound $|X_{r,r}|$ instead of $|X_r|$.

Theorem 1.16

There exists a $C > 0$ such that for all $r \geq 1$ and $0 \leq \epsilon < 1$:

$$\mathbb{P}_{IIC}(|X_{r,r}| \leq \epsilon \cdot r^3) \leq C \cdot \epsilon$$

and as a consequence, because $|X_{r,r}| \leq |X_r|$ for all r :

$$\mathbb{P}_{IIC}(\underline{d}_m(IIC) \geq 3) = 1.$$

Our strongest rigorous *unconditional* results on the mass dimension and discrete Hausdorff dimensions of the IIC can now be summarized as:

Corollary 1.17

$$\mathbb{P}_{IIC}(3 \leq \underline{d}_m(IIC) \leq \overline{d}_m(IIC) \leq 4) = 1$$

and for all functions $\epsilon(r)$ for which $d_{\mathcal{H},\epsilon(r)}$ is defined it holds that

$$\mathbb{P}_{IIC}(d_{\mathcal{H},\epsilon(r)}(IIC) \leq \overline{d}_m(IIC) \leq 4) = 1.$$

1.8 Motivation for Conjecture 1.12

Why the conjecture that $d_m(IIC) = 4$ and $d_m(Bb^*) = 2$ and that the same values occur for the discrete Hausdorff dimension, \mathbb{P}_{IIC} -almost surely? Before we present some motivations: first note that -provided the mass dimension exists- it would suffice to bound the discrete Hausdorff dimension from below by the conjectured values. Indeed, we know (Lemma 5.4) that the discrete Hausdorff dimension is bounded above by the upper mass dimension, and the upper mass dimensions of the IIC and the backbone Bb^* are already almost surely bounded above by their conjectured values (Corollary 1.11).

The conjectured scaling limit of the IIC, respectively the backbone, has Hausdorff dimension 4, respectively 2.

In ([20],[21],[22]) Hara and Slade approach the IIC by taking the scaling limit of increasingly large but finite clusters at $p = p_c$. This involves shrinking the lattice spacing as a function of the cluster size n in such a way that for $n \rightarrow \infty$ a (nontrivial) random subset of \mathbb{R}^d is produced. In order to achieve this, the lattice spacing is scaled down by a factor n^{1/D_H} , where $D_H = 4$ is the presumed Hausdorff dimension of the IIC. This procedure is analogous to the way in which Brownian motion in a time interval $[0, 1]$ can be constructed [14] as a limit of an increasingly long random walk on a lattice, in which case the lattice spacing is scaled down by a factor $n^{1/2}$ because Brownian motion almost surely has Hausdorff dimension 2.

Let $x \in \mathbb{R}$ be fixed. Hara and Slade showed that in sufficiently high dimension, the probability that a site $\lfloor xn^{1/4} \rfloor$ is connected to the origin in a cluster of size n corresponds, in the scaling limit $n \rightarrow \infty$, to the mean mass density function of *integrated super-Brownian excursion (ISE)* at x . ISE is a random probability measure on \mathbb{R}^d . For $d > 4$ the support of this random probability measure almost surely has Hausdorff dimension 4 [15]! This suggests that the scaling limit of the IIC is ISE and almost surely has discrete Hausdorff dimension 4. As it turns out though this is difficult to prove; it already is very complicated and laborious to explicitly derive the scaling limit of $\mathbb{P}_{p_c}(A)$ for just the two events $A = \{\lfloor xn^{1/4} \rfloor \text{ is connected to the origin in a cluster of size } n\}$ and $A = \{\lfloor xn^{1/4} \rfloor \text{ and } \lfloor yn^{1/4} \rfloor \text{ are connected to the origin in a cluster of size } n\}$.

As to the backbone, it is conjectured and a proof is being prepared [16] that its scaling limit is Brownian motion, which almost surely has Hausdorff dimension 2 [14], supporting the conjecture that the backbone almost surely has discrete Hausdorff dimension 2.

Aizenman: the maximal spanning cluster in Q_r is of order r^4

Let $\partial Q_r^+ = \{(x_1, \dots, x_d) \in Q_r | x_1 = r\}$ and $\partial Q_r^- = \{(x_1, \dots, x_d) \in Q_r | x_1 = -r\}$ be the ‘left’ and the ‘right’ boundary of the cube Q_r . A spanning cluster is a cluster (collection of interconnected vertices) that intersects both ∂Q_r^+ and ∂Q_r^- . Define $|\mathcal{C} \cap Q_r|_{max}$ as the maximal value of $|\mathcal{C} \cap Q_r|$ where the maximum is taken over all clusters \mathcal{C} that intersect both ∂Q_r^+ and ∂Q_r^- .

In [10], Aizenman sketches a proof that in any dimension $d > 6$ for which assumption (1.3) holds true, the spanning probability tends to 1 as $r \rightarrow \infty$ and:

$$\lim_{r \rightarrow \infty} \mathbb{P}_{p_c} (o(r) \cdot r^4 \leq |\mathcal{C} \cap Q_r|_{max} \leq c \cdot \log(r) \cdot r^4) = 1 \tag{1.20}$$

for any function $o(r)$ which tends to 0 as $r \rightarrow \infty$.

So although we know that there is no infinite cluster for percolation at $p = p_c$, the result of Aizenman shows that there *are* arbitrarily large spanning clusters; for all r there typically exists a (finite) cluster that is of order r^4 and spans the box Q_r . So everywhere in \mathbb{Z}^d there are finite clusters that are locally of the order that is conjectured to hold for the (infinite) IIC. From Figure 1 and translation invariance it even becomes clear that the event in (1.20) implies that there almost surely is a cluster of order r^4 that intersects the boundaries of the nested cubes Q_r and $Q_{r/2}$.

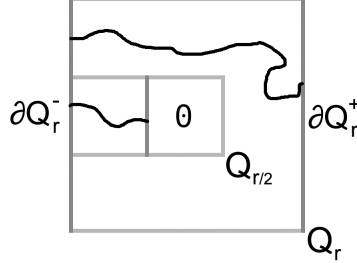

Figure 1: For critical percolation in dimension $d > 6$ there exists a (maximal) cluster that spans the ball Q_r and has $\asymp r^4$ vertices in Q_r , with probability tending to 1 as $r \rightarrow \infty$. In this picture both the ball Q_r and a translated ball with radius $r/2$ are spanned by an open path.

1.9 Approaches that didn't work

Tweaking Aizenmans proof

It would come as no surprise that the lower bounds on Aizenman's maximal cluster survive if we consider the probabilities w.r.t. \mathbb{P}_{IIC} instead of \mathbb{P}_{p_c} as this - so to speak- only *adds* a connection between 0 and ∞ . But of course a stronger result is preferred; we want to know whether $|IIC \cap Q_r|$ is also of order r^4 . However, the intricate dependency on the vertex 0 that lies at the heart of both the IIC-measure and the IIC itself causes the kind of moment bounds in Aizenmans proof to fail fatally; relevant events A, B that say something about the magnitude of the IIC typically involve the connection of some vertex with 0, but this very property makes that these events *don't* occur disjointly with high probability, so $\mathbb{P}_{IIC}(A \text{ not disjoint } B) \approx \mathbb{P}_{IIC}(A \cap B)$, while Aizenmans proof relies on events for which $\mathbb{P}_{p_c}(A \text{ not disjoint } B) \ll \mathbb{P}(A \cap B)$. A second problem is that the BK-inequality, frequently used in Aizenmans proof, does not need to hold for the IIC-measure, but this is less severe because we can always use a construction of the IIC-measure in terms of \mathbb{P}_{p_c} , for which the BK-inequality does hold.

Explicitly: Aizenman writes

$$|\mathcal{C} \cap Q_r|_{max} \geq \frac{\sum_{\mathcal{C}} |\mathcal{C} \cap Q_r| \cdot |\mathcal{C} \cap \partial Q_r^+| \cdot |\mathcal{C} \cap \partial Q_r^-|}{\sum_{\mathcal{C}} |\mathcal{C} \cap \partial Q_r^+| \cdot |\mathcal{C} \cap \partial Q_r^-|} := \frac{H_r}{K_r}$$

where the summation is over all clusters \mathcal{C} that intersect Q_r . Subsequently it is shown that

$$\mathbb{E}_{p_c} \left(\left(\frac{K_r}{\mathbb{E}_{p_c}(K_r)} - 1 \right)^2 \right) = \frac{\mathbb{E}_{p_c}(K_r^2) - \mathbb{E}_{p_c}(K_r)^2}{\mathbb{E}_{p_c}(K_r)^2} \leq C \cdot \frac{r^{d+6}}{(r^d)^2} \rightarrow 0 \text{ as } r \rightarrow \infty,$$

leading to $\lim_{r \rightarrow \infty} \mathbb{P}_{p_c} \left(\frac{1}{o(r)} r^d \leq K_r \leq o(r) r^d \right) = 1$ for all positive functions $o(r)$ with $\lim_{r \rightarrow \infty} o(r) = 0$. Together with a similar result for H_r (and Markov's inequality) this shows (1.20). The most difficult step is bounding $\mathbb{E}_{p_c}(H_r^2) - \mathbb{E}_{p_c}(H_r)^2$; it involves several applications of the BK-inequality and convolution bounds.

One of the many ways it has been tried, in vain, to bend this proof in order to let it work for bounding the IIC is simply writing:

$$|IIC \cap Q_r| = \frac{\sum_{\mathcal{C}} |IIC \cap Q_r| \cdot |\mathcal{C} \cap \partial Q_r^+| \cdot |\mathcal{C} \cap \partial Q_r^-|}{\sum_{\mathcal{C}} |\mathcal{C} \cap \partial Q_r^+| \cdot |\mathcal{C} \cap \partial Q_r^-|} := \frac{H'_r}{K_r}.$$

Zero one laws and (in)dependence

A zero-one law states that, under certain conditions, the probability that an event occurs is either 0 or 1. The idea behind applying a zero-one law is: first try to prove that $\mathbb{P}_{IIC}(d_m(IIC) = 4) > 0$ (which is already difficult) and then use a zero-one law to conclude that $\mathbb{P}_{IIC}(d_m(IIC) = 4) = 1$. The problem is that laws like the Kolmogorov 0-1 law and the Hewitt-Savage 0-1 law ([17]), as well as approximate zero-one laws ([18], [19]) require independence of certain events *and /or* they require specific properties of the probability measure ('product measure', 'monotone measure' ...) that are not satisfied by the IIC-measure. As to the independence issue: the inherent role of the origin 0 in both the IIC and the construction of the IIC-measures introduces weird, sometimes counterintuitive, dependencies. A simple example: let b a bond adjacent to the origin, then $\mathbb{P}_{IIC}(b \text{ is open} \mid \text{all other bonds around the origin are closed}) = 1 \neq \mathbb{P}_{IIC}(b \text{ is open})$. The most promising approach is the following, in which we partially neutralize the dependency on the origin by considering $\mathcal{C}(Q_r)$ instead of $\mathcal{C}(0)$, using the following 0 – 1 law.

Lemma 1.18 (Proof can be found in [17])

Let $(\Omega, \mathcal{F}, \mathbb{P})$ be a probability space. Let A_1, A_2, \dots be a collection of events, and let \mathcal{A} be the smallest σ -field of subsets of Ω which contains all of them. If $A \in \mathcal{A}$ is an event which is independent of the finite collection A_1, A_2, \dots, A_r for each value of r , then $\mathbb{P}(A) \in \{0, 1\}$.

Define $\mathcal{C}(Q_r) := \left\{ x \in \mathbb{Z}^d \setminus Q_r \mid \text{there is an } y \in \partial Q_r \text{ such that } y \overset{\mathbb{Z}^d \setminus Q_r}{\longleftrightarrow} x \right\}$. Provided there is an open path from 0 to ∞ and there exists exactly one infinite cluster (which is true \mathbb{P}_{IIC} -almost surely), it holds for all $r > 0$ that

$$d_m(\mathcal{C}(Q_r) \setminus Q_r) = 4 \Leftrightarrow d_m(\mathcal{C}(0)) = 4$$

and as a consequence

$$A := \liminf_{r \rightarrow \infty} \{d_m(\mathcal{C}(Q_r) \setminus Q_r) = 4\} = \{d_m(IIC) = 4\}.$$

Finally one would want to apply Lemma 1.18 to A and $A_i := \{ \text{bond } e_i \text{ is open} \}$ to conclude that $\mathbb{P}(A) \in \{0, 1\}$. The problem is: are we indeed allowed to apply Lemma 1.18; is A independent of the collection A_1, A_2, \dots, A_r for each r , with respect to the IIC-measure? Note that if this is true, a slight adaptation of the proof would immediately yield that for all α it holds that $\mathbb{P}_{IIC}(d_m(IIC) = \alpha) \in \{0, 1\}$ and $\mathbb{P}_{IIC}(\overline{d_m(IIC)} = \alpha) \in \{0, 1\}$.

Positive probability as in Theorem 1.14 is not strong enough

By Theorem 1.14 we have that for a given $0 < \epsilon < 1$ there is a constant $C > 0$ such that $\mathbb{P}_{IIC}(|X_r| \geq \epsilon \cdot \mathbb{E}_{IIC}(|X_r|)) \geq C$. So for all radii r we have that $|X_r|$ is approximately r^4 with positive probability bounded away from zero. At first sight this implies that the mass dimension of the IIC is 4 with positive probability, but to conclude this one would actually need a stronger statement of the form $\mathbb{P}_{IIC}(|X_r| \geq \epsilon \cdot \mathbb{E}_{IIC}(|X_r|)) \geq 1 - \epsilon(r)$, such that $\sum_{r=1}^{\infty} \epsilon(r) < \infty$, because then Borel-Cantelli would imply that $\mathbb{P}_{IIC}(d_m(IIC) \geq 4) = \mathbb{P}_{IIC}(\liminf_{r \rightarrow \infty} \log_r(|X_r|) \geq 4) = \mathbb{P}_{IIC}(\log_r(|X_r|) \geq \epsilon \cdot r^4 \text{ for only finitely many } r) \approx \mathbb{P}_{IIC}(|X_r| \leq \epsilon \cdot \mathbb{E}_{IIC}(|X_r|) \text{ i.o.}) = 0$.

1.10 Closing remark

For further research we would advise to investigate and generalize the proof of Theorem 1.16 because it provides, with relatively little effort, our strongest rigorous result on the lower mass dimension of the IIC. The full potential of the underlying method probably has not been explored yet, as this theorem came up in the final stage of the research for this thesis.

2 Technical lemmas, tree diagrams and moment bounds

2.1 Technical lemmas, convolution and bounding small diagrams

This section is all about technical lemmas on bounds of sums, products and convolutions involving the function $\tau(x - y)$. Recall that $\tau(x - y) := \mathbb{P}_{p_c}(x \leftrightarrow y) \asymp |x - y|^{2-d}$. From now on we let $\|x\|$ denote $\max(|x|, 1)$, for all $x \in \mathbb{Z}^d$.

Lemma 2.1

For all $k \leq d, y \in \mathbb{Z}^d$ and $r \geq 1$:

$$\sum_{x \in Q_r} \frac{1}{\|x - y\|^{d-k}} \leq \sum_{x \in Q_r} \frac{1}{\|x\|^{d-k}}. \quad (2.1)$$

Proof. The function $f: Q_r \cap (-Q_r + \{y\}) \rightarrow Q_r \cap (-Q_r + \{y\})$ defined by $f(x) = -x + y$ is a bijection. Therefore

$$\sum_{\substack{x \in Q_r \\ y-x \in Q_r}} \frac{1}{\|x - y\|^{d-k}} = \sum_{x \in Q_r \cap (-Q_r + \{y\})} \frac{1}{\|f(x)\|^{d-k}} = \sum_{x \in Q_r \cap (-Q_r + \{y\})} \frac{1}{\|x\|^{d-k}} = \sum_{\substack{x \in Q_r \\ y-x \in Q_r}} \frac{1}{\|x\|^{d-k}}.$$

Furthermore: for all $x \in Q_r$ such that $y - x \notin Q_r$ it holds that $\|x - y\| > r \geq \|x\|$, so

$$\sum_{\substack{x \in Q_r \\ y-x \notin Q_r}} \frac{1}{\|x - y\|^{d-k}} \leq \sum_{\substack{x \in Q_r \\ y-x \notin Q_r}} \frac{1}{\|x\|^{d-k}}.$$

□

For generalizations of the results in this section, a bound for more general sets S_1, \dots, S_r, \dots , of the form

$$\sum_{x \in S_r} \frac{1}{\|x - y\|^{d-k}} \leq C \cdot \sum_{x \in S_r} \frac{1}{\|x\|^{d-k}}$$

would be useful, but unfortunately this doesn't even hold true for important simple sets like $S_r = \partial Q_r$, so we will not pursue this route.

Lemma 2.2

For all $k > 0$ there are constants $c, C > 0$ such that for all $r \geq 1$:

$$c \cdot r^k \leq \sum_{x \in Q_r} \frac{1}{\|x\|^{d-k}} \leq C \cdot r^k \quad (2.2)$$

and

$$c \cdot \frac{1}{r^k} \leq \sum_{x \notin Q_r} \frac{1}{\|x\|^{d+k}} \leq C \cdot \frac{1}{r^k}. \quad (2.3)$$

Proof. We will actually prove the slightly more general result stated in (2.7) below. First note that the Euclidean norm $|\cdot|_e$ and the supremum norm $|\cdot|$ are equivalent norms on \mathbb{R}^d . So there exist constants $c, C > 0$ such that for all $b_1, b_2 \in \mathbb{R}_{\geq 1}$:

$$c \cdot \sum_{\substack{x \in \mathbb{Z}^d \\ b_1 \leq |x|_e \leq b_2}} \frac{1}{|x|_e^{d-k}} \leq \sum_{\substack{x \in \mathbb{Z}^d \\ b_1 \leq |x| \leq b_2}} \frac{1}{|x|^{d-k}} \leq C \cdot \sum_{\substack{x \in \mathbb{Z}^d \\ b_1 \leq |x|_e \leq b_2}} \frac{1}{|x|_e^{d-k}}. \quad (2.4)$$

Furthermore, there exist constants $c', C' > 0$ such that for all $x \in \mathbb{Z}^d \setminus \{0\}$ and $x^* \in [-1/2, 1/2]^d$ it holds that $c' \cdot |x|_e \leq |x + x^*|_e \leq C' \cdot |x|_e$ and also:

$$\bigcup_{\substack{x \in \mathbb{R}^d \\ b_1 \leq |x|_e \leq b_2}} x \subset \bigcup_{\substack{x \in \mathbb{Z}^d \\ b_1 \leq |x|_e \leq b_2}} \left(x + \left[-\frac{1}{2}, \frac{1}{2} \right]^d \right) \subset \bigcup_{\substack{x \in \mathbb{R}^d \\ -\frac{\sqrt{d}}{2} + b_1 \leq |x|_e \leq b_2 + \frac{\sqrt{d}}{2}}} x.$$

As a consequence we can approximate the outer sums in (2.4) by an integral:

$$c' \cdot \int_{\left(\substack{x \in \mathbb{R}^d \\ b_1 \leq |x|_e \leq b_2} \right)} \frac{1}{|x|_e^{d-k}} dx \leq \sum_{\substack{x \in \mathbb{Z}^d \\ b_1 \leq |x|_e \leq b_2}} \frac{1}{|x|_e^{d-k}} \leq C' \cdot \int_{\left(\substack{x \in \mathbb{R}^d \\ -\frac{\sqrt{d}}{2} + b_1 \leq |x|_e \leq b_2 + \frac{\sqrt{d}}{2} \right)} \frac{1}{|x|_e^{d-k}} dx. \quad (2.5)$$

Using spherical coordinates in d -dimensional Euclidean space this integral can be calculated:

$$\begin{aligned} & \int_{\left(\substack{x \in \mathbb{R}^d \\ b_1 \leq |x|_e \leq b_2} \right)} \frac{1}{|x|_e^{d-k}} dx \\ &= \int_0^{2\pi} \int_0^\pi \dots \int_0^\pi \int_{b_1}^{b_2} \left(\frac{1}{r^{d-k}} \right) \cdot r^{d-1} \cdot \sin^{d-2}(\phi_1) \sin^{d-3}(\phi_2) \dots \sin(\phi_{d-2}) dr d\phi_1 \dots d\phi_{d-1} \\ &= V \cdot \frac{(b_2^k - b_1^k)}{k} \end{aligned} \quad (2.6)$$

where V is a constant independent of k, b_1, b_2 (and V is equal to d times the volume of the d -dimensional Euclidean ball with radius 1).

Combining (2.4), (2.5) and (2.6) we see that there exist constants $c'', C'' > 0$ such that for all $k \neq 0$ and b_2, b_1 such that $b_2 \geq b_1 \geq \frac{\sqrt{d}}{2}$:

$$c'' \cdot \frac{(b_2^k - b_1^k)}{k} \leq \sum_{\substack{x \in \mathbb{Z}^d \\ b_1 \leq |x|_e \leq b_2}} \frac{1}{|x|_e^{d-k}} \leq C'' \cdot \frac{\left((b_2 + \frac{\sqrt{d}}{2})^k - (b_1 - \frac{\sqrt{d}}{2})^k \right)}{k}. \quad (2.7)$$

To prove the lemma we now merely need to choose the right parameters in inequality (2.7). If we choose $k < 0$, $b_1 = r$ and let $b_2 \rightarrow \infty$ then we obtain (2.3). If we choose $k > 0$, $b_1 = \frac{\sqrt{d}}{2}$ and $b_2 = r$ then we obtain (2.2), since we may ignore the (finite and r -independent) sum $\sum_{\substack{x \in \mathbb{Z}^d \\ |x|_e \leq \frac{\sqrt{d}}{2}}} \frac{1}{|x|_e^{d-k}}$. □

Lemma 2.3 (Convolution bound [23])

If functions f, g on \mathbb{Z}^d satisfy $|f(x)| \leq \|x\|^{-a}$ and $|g(x)| \leq \|x\|^{-b}$ with $a \geq b > 0$, then there exists a constant C depending on a, b, d such that

$$|(f * g)(x)| \leq C \cdot \begin{cases} \|x\|^{-b} & \text{if } a > d \\ \|x\|^{d-(a+b)} & \text{if } a < d \text{ and } a + b > d. \end{cases}$$

Proof. This proof is the same as the proof found in Proposition 1.7 in [23], only with a little more explanation. By definition,

$$|(f * g)(x)| \leq \sum_{\substack{y \in \mathbb{Z}^d \\ |x-y| \leq |y|}} \frac{1}{\|x-y\|^a} \frac{1}{\|y\|^b} + \sum_{\substack{y \in \mathbb{Z}^d \\ |x-y| > |y|}} \frac{1}{\|x-y\|^a} \frac{1}{\|y\|^b}.$$

Using $a \geq b$ and the change of variables $z = x - y$ in the second term, we see that

$$|(f * g)(x)| \leq 2 \cdot \sum_{\substack{y \in \mathbb{Z}^d \\ |x-y| \leq |y|}} \frac{1}{\|x-y\|^a} \frac{1}{\|y\|^b}. \quad (2.8)$$

In the above summation, $|y| \geq \frac{1}{2}|x|$. Therefore it follows from (2.3) that if $a > d$:

$$|(f * g)(x)| \leq \frac{2^{b+1}}{\|x\|^b} \cdot \sum_{\substack{y \in \mathbb{Z}^d \\ |x-y| \leq |y|}} \frac{1}{\|x-y\|^a} \leq C \cdot \|x\|^{-b}. \quad (2.9)$$

Suppose now that $a < d$ and $a + b > d$. We split the sum on the right hand side of (2.8) in two parts.

Case 1: $\frac{1}{2}|x| \leq |y| \leq \frac{3}{2}|x|$:

$$\begin{aligned} \sum_{\substack{y \in \mathbb{Z}^d \\ |x-y| \leq |y| \\ \frac{1}{2}|x| \leq |y| \leq \frac{3}{2}|x|}} \frac{1}{\|x-y\|^a} \frac{1}{\|y\|^b} &\leq \frac{2^{b+1}}{\|x\|^b} \sum_{\substack{y \in \mathbb{Z}^d \\ |x-y| \leq \frac{3|x|}{2}}} \frac{1}{\|x-y\|^a} \\ &= \frac{2^{b+1}}{\|x\|^b} \sum_{z \in Q_{\frac{3|x|}{2}}} \frac{1}{\|z\|^a} \\ &\leq \frac{C}{\|x\|^b} \cdot \|x\|^{d-a}, \end{aligned} \quad (2.10)$$

where the last inequality follows from the the bound in (2.2).

Case 2: $|y| \geq \frac{3}{2}|x|$:

In this case $|y-x| \geq |y| - |x| \geq \frac{|y|}{3}$. So by the bound in (2.3):

$$\sum_{\substack{y \in \mathbb{Z}^d \\ |x-y| \leq |y| \\ |y| \geq \frac{3}{2}|x|}} \frac{1}{\|x-y\|^a} \frac{1}{\|y\|^b} \leq 3^a \cdot 2 \cdot \sum_{\substack{y \in \mathbb{Z}^d \\ |y| \geq \frac{3|x|}{2}}} \frac{1}{\|y\|^{a+b}} \leq \frac{C}{\|x\|^{a+b-d}}. \quad (2.11)$$

Now evaluate (2.10) and (2.11) in (2.8) to obtain the desired inequality. \square

By combining the Lemmas 2.1, 2.2 and 2.3 with the bound (1.3) on the two-point function, we obtain the following useful bounds.

Lemma 2.4

There exist constants $C, C', C'' > 0$ such that for all $y \in \mathbb{Z}^d$,

(i)

$$\sum_{x \in Q_r} \tau(x-y) \leq C' \cdot \sum_{x \in Q_r} \tau(x) \leq C'' \cdot \sum_{x \in Q_r} \frac{1}{\|x\|^{d-2}} \leq C \cdot r^2,$$

(ii)

$$\sum_{x \in Q_r} (\tau * \tau)(x-y) \leq C' \cdot \sum_{x \in Q_r} (\tau * \tau)(x) \leq C'' \cdot \sum_{x \in Q_r} \frac{1}{\|x\|^{d-4}} \leq C \cdot r^4,$$

and for all $s, t \in \mathbb{R}$ such that $(s+t-1)d - 2(s+2t) > 0$,

(iii)

$$\sum_{x \notin Q_r} \tau(x)^s \cdot (\tau * \tau)^t(x) \leq C' \cdot \sum_{x \notin Q_r} \frac{1}{\|x\|^{(s+t)d-2(s+2t)}} \leq C \cdot \frac{1}{r^{(s+t-1)d-2(s+2t)}}.$$

The estimates in Lemma 2.4 are already sufficient to bound $\mathbb{E}_{IIC}(|X_r|)$ and $\mathbb{E}_{IIC}(|X_r|^2)$ from above, as will be demonstrated in Lemma 2.16. But to bound other expectations, like $\mathbb{E}_{IIC}(|X_r|^n)$ for general $n \in \mathbb{N}$, we need a more inductive approach to bound a so called tree diagram (see the next subsection for its definition). At the basis of this inductive approach are the following technical Lemmas 2.5 and 2.7, that -in particular- bound two small ‘diagrams’ that are the building blocks of an arbitrary tree diagram. See Figures 2 and 3.

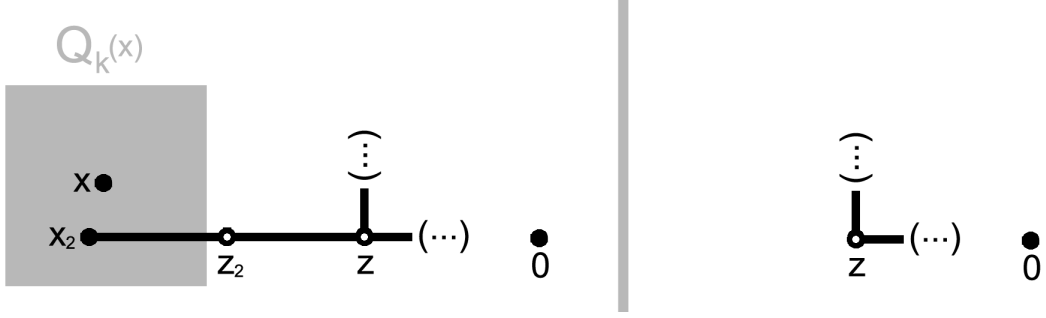

Figure 2: These tree diagrams illustrate Lemma 2.5. The vertices $z, 0$ and x are fixed. The dots denote other vertices and edges of the tree diagram that are not involved in the computation of Lemma 2.5. The left hand side is summed over all $x_2 \in Q_r \cap Q_k(x)$ and $z_2 \in \mathbb{Z}^d$. Up to a constant value it is bounded above by $\min(k^4, r^4)$ times the right hand side.

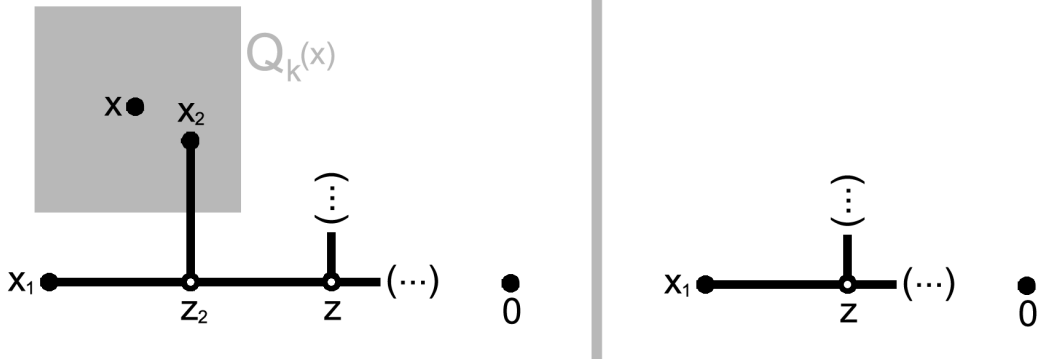

Figure 3: These tree diagrams illustrate Lemma 2.7. The vertices $z, 0$ and x are fixed. The dots denote other vertices and edges of the tree diagram that are not involved in the computation of Lemma 2.7. The left hand side is summed over all $x_2 \in Q_{r_2} \cap Q_k(x)$ and $z_2 \in \mathbb{Z}^d$ and $x_1 \in Q_{r_1}$. Up to a constant value it is bounded from above by $\max(k^4, r_2^4)$ times (the right hand side summed over $x_1 \in Q_{r_1}$).

Lemma 2.5

There is a constant C such that for all $z \in \mathbb{Z}^d, x \in Q_r, k, r \in \mathbb{N}$:

$$\delta_{k,r}(z, x) := \sum_{\substack{x_2 \in Q_r \\ |x - x_2| \leq k \\ z_2 \in \mathbb{Z}^d}} \tau(z - z_2) \tau(z_2 - x_2) \leq C \cdot \min(k^4, r^4).$$

Proof. The substitution $u := x_2 - x$ and the equivalence $|x - x_2| \leq k \Leftrightarrow x_2 - x \in Q_k$ yield

$$\begin{aligned} \delta_{k,r}(z, x) &= \sum_{\substack{u+x \in Q_r \\ u \in Q_k}} \sum_{z_2 \in \mathbb{Z}^d} \tau(z - z_2) \tau(z_2 - x - u) \\ &= \sum_{\substack{u \in Q_k \\ u+x \in Q_r}} \sum_{z_2 \in \mathbb{Z}^d} \tau(z_2 - z) \tau(u + x - z_2) \\ &= \sum_{\substack{u \in Q_k \\ u+x \in Q_r}} \sum_{z_2 \in \mathbb{Z}^d} \tau(z_2) \tau(u + x - z - z_2) \\ &= \sum_{\substack{u \in Q_k \\ u+x \in Q_r}} (\tau * \tau)(u + x - z) \\ &\leq C \cdot \min(k^4, r^4), \end{aligned}$$

where the second equality is just the symmetry of the two-point function and the third equality is

the result of summing over $z_2 + z \in \mathbb{Z}^d$ instead of $z_2 \in \mathbb{Z}^d$. The final inequality follows from Lemma 2.4.ii. □

The following is an important corollary of Lemma 2.5.

Corollary 2.6

There is a constant C such that for all $z \in \mathbb{Z}^d, r \in \mathbb{N}$:

$$\delta_{\infty,r}(z, 0) = \sum_{\substack{x \in Q_r \\ z_2 \in \mathbb{Z}^d}} \tau(z - z_2) \tau(z_2 - x) \leq C \cdot r^4.$$

Lemma 2.7

There exists a constant C such that for all $z, x \in \mathbb{Z}^d$ and $k, r_1, r_2 \in \mathbb{N}$:

$$\begin{aligned} \eta_{k,r_1,r_2}(z, x) &:= \sum_{z_2 \in \mathbb{Z}^d} \sum_{\substack{x_1 \in Q_{r_1} \\ x_2 \in Q_{r_2} \\ |x - x_2| \leq k}} \tau(z_2 - x_1) \tau(z_2 - x_2) \tau(z - z_2) \\ &\leq C \cdot \min(k^4, r_2^4) \cdot \sum_{x_1 \in Q_{r_1}} \tau(z - x_1) \end{aligned} \quad (2.12)$$

and also

$$\begin{aligned} \eta_{k,r_1,r_2}(z) &:= \sum_{z_2 \in \mathbb{Z}^d} \sum_{\substack{x_1 \in Q_{r_1} \\ x_2 \in Q_{r_2} \\ |x_1 - x_2| \leq k}} \tau(z_2 - x_1) \tau(z_2 - x_2) \tau(z - z_2) \\ &\leq C \cdot \min(k^4, r_2^4) \cdot \sum_{x_1 \in Q_{r_1}} \tau(z - x_1). \end{aligned} \quad (2.13)$$

Proof. We will prove inequality (2.12). It turns out that all bounds in the proof remain valid (and independent of x_1) if we replace x by x_1 everywhere, thus also yielding a proof for inequality (2.13).

Observe that $|x - x_2| \leq k \Leftrightarrow x_2 - x \in Q_k$, so substituting $u := x_2 - x$ yields

$$\eta_{k,r_1,r_2}(z, x) = \sum_{z_2 \in \mathbb{Z}^d} \sum_{\substack{x_1 \in Q_{r_1} \\ u+x \in Q_{r_2} \\ u \in Q_k}} \tau(z_2 - x_1) \tau(z_2 - u - x) \tau(z - z_2). \quad (2.14)$$

We will split the sum on the right hand side in two parts and we will bound them separately.

Case 1: $|z_2 - z| \geq \frac{1}{2}|x_1 - z|$

In this case there is a constant C' such that $\tau(z_2 - z) \leq C' \cdot \tau(x_1 - z)$. Therefore:

$$\begin{aligned} \sum_{\substack{z_2 \in \mathbb{Z}^d \\ |z_2 - z| \geq \frac{|x_1 - z|}{2}}} \tau(z_2 - x_1) \tau(z_2 - u - x) \tau(z_2 - z) &\leq C' \tau(x_1 - z) \sum_{z_2 \in \mathbb{Z}^d} \tau(z_2 - x_1) \tau(z_2 - u - x) \\ &= C' \cdot \tau(x_1 - z) \cdot \sum_{z_2 \in \mathbb{Z}^d} \tau(z_2 + u + x - x_1) \tau(z_2) \\ &= C' \cdot \tau(x_1 - z) \cdot (\tau * \tau)(u + x - x_1). \end{aligned} \quad (2.15)$$

Case 2: $|z_2 - z| \leq \frac{1}{2}|x_1 - z|$

In this case $|z_2 - x_1| \geq |x_1 - z| - |z_2 - z| \geq |x_1 - z| - \frac{|x_1 - z|}{2} = \frac{|x_1 - z|}{2}$. So $\tau(z_2 - x_1) \leq C' \cdot \tau(x_1 - z)$.

Therefore we can apply virtually the same derivation as in Case 1:

$$\begin{aligned}
\sum_{\substack{z_2 \in \mathbb{Z}^d \\ |z_2 - z| \leq \frac{|x_1 - z|}{2}}} \tau(z_2 - x_1) \tau(z_2 - u - x) \tau(z_2 - z) &\leq C' \tau(x_1 - z) \sum_{z_2 \in \mathbb{Z}^d} \tau(z_2 - u - x) \tau(z_2 - z) \\
&= C' \cdot \tau(x_1 - z) \cdot (\tau * \tau)(u + x - z). \quad (2.16)
\end{aligned}$$

Finally combine bounds (2.14), (2.15) and (2.16) to obtain the first of the following two inequalities, and use Lemma 2.4 (ii) for the second inequality:

$$\begin{aligned}
\eta_{k,r_1,r_2}(z, x) &\leq C' \cdot \left(\sum_{x_1 \in Q_r} \tau(x_1 - z) \cdot \left(\sum_{\substack{u \in Q_k \\ u+x \in Q_{r_2}}} (\tau * \tau)(u + x - x_1) + (\tau * \tau)(u + x - z) \right) \right) \\
&\leq C'' \cdot \min(k^4, r_2^4) \cdot \left(\sum_{x_1 \in Q_r} \tau(x_1 - z) \right).
\end{aligned}$$

□

The following is an important corollary of Lemma 2.7.

Corollary 2.8

There exists a constant C , independent of $z \in \mathbb{Z}^d, r_1, r_2 \in \mathbb{N}$, such that:

$$\eta_{\infty, r_1, r_2}(z, 0) = \sum_{z_2 \in \mathbb{Z}^d} \sum_{\substack{x_1 \in Q_{r_1} \\ x_2 \in Q_{r_2}}} \tau(z_2 - x_1) \tau(z_2 - x_2) \tau(z - z_2) \leq C \cdot r_2^4 \cdot \sum_{x_1 \in Q_{r_1}} \tau(z - x_1).$$

2.2 Bounding expectation values by bounding tree diagrams

In this section the main object is to estimate some expectation values, culminating in Theorem 2.10. In doing so we often need to bound functions on vertices that are organized in a treelike way. Typically we are dealing with an *unrooted binary tree on n labeled external vertices* (and $n - 2$ unordered internal vertices), which we will mostly refer to as a *tree diagram on n labeled vertices*. By definition, an unrooted binary tree is a binary tree in which each vertex has either one or three neighbours. Vertices with one neighbour are called *external vertices*, while those with three neighbours are called *internal vertices*. The next Lemma enumerates tree diagrams on $n + 2$ labeled vertices.

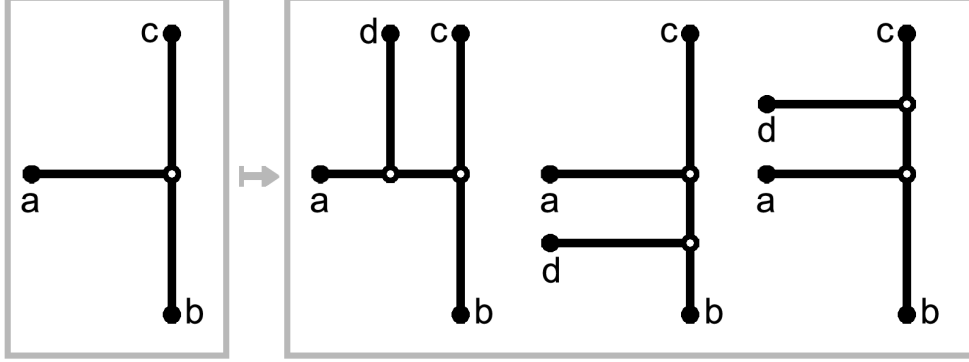

Figure 4: On the left the unique tree diagram on three labeled vertices is shown. From this the three possible tree diagrams on four labeled vertices, shown on the right, can be constructed.

Lemma 2.9

Let $n \in \mathbb{N}$ and let $\mathcal{T}(n)$ denote the number of unrooted binary trees ('tree diagrams') on $n + 2$ labeled external vertices. Then

$$\mathcal{T}(n) = \frac{(2n)!}{2^n \cdot n!}.$$

Proof. Let $\mathcal{E}(n)$ be the number of edges in a tree diagram connecting $n + 2$ vertices. The initial conditions are $\mathcal{T}(0) = 1$ and $\mathcal{E}(0) = 1$. A diagram T^* on $n + 3$ vertices is obtained from a diagram T on $n + 2$ vertices by connecting a new $(n + 3)$ -th external vertex to a new internal vertex that is placed in the middle of some existing edge in T , as depicted in Figure 4. This procedure adds two vertices and two edges, so: $\mathcal{E}(n + 1) = \mathcal{E}(n) + 2$ and therefore $\mathcal{E}(n) = 2n + 1$. Furthermore, in each of the $\mathcal{T}(n)$ diagrams there are $\mathcal{E}(n)$ edges to choose from to append a new vertex, so $\mathcal{T}(n + 1) = \mathcal{T}(n) \cdot \mathcal{E}(n) = \mathcal{T}(n) \cdot (2n + 1)$. The solution of this recurrence relation is $\mathcal{T}(n) = \prod_{i=0}^{n-1} (2i + 1) = \frac{(2n)!}{\prod_{i=1}^n (2i)} = \frac{(2n)!}{2^n \cdot n!}$. \square

Theorem 2.10

Let C denote the maximum of the constants appearing in Lemma 2.5 and 2.7. For all $k_1, \dots, k_m \in \mathbb{N}$ and all $r_1, \dots, r_m, \dots, r_{m+n} \in \mathbb{N}$ it holds that:

$$\mathbb{E}_{IIC} \left(\prod_{i=1}^m \left(\sum_{\substack{x, y \in \mathcal{C}(0) \cap Q_{r_i} \\ |x-y| \leq k_i}} 1 \right) \cdot \prod_{i=m+1}^{m+n} \left(\sum_{x \in \mathcal{C}(0) \cap Q_{r_i}} 1 \right) \right) \leq C^{2m+n} \cdot \mathcal{T}(2m+n) \cdot \prod_{i=1}^m k_i^4 \cdot \prod_{i=1}^{m+n} r_i^4.$$

Corollary 2.11

There exist constants $C, C_1 > 0$ such that for all $r, n \in \mathbb{N}$:

$$\mathbb{E}_{IIC}(|X_r|^n) := \mathbb{E}_{IIC} \left(\left(\sum_{x \in \mathcal{C}(0) \cap Q_r} 1 \right)^n \right) \leq C^n \cdot \frac{(2n)!}{2^n \cdot n!} \cdot r^{4n} \leq C_1^n \cdot \frac{(2n)!}{2^n \cdot n!} \cdot \mathbb{E}_{IIC}(|X_r|)^n.$$

Corollary 2.12

There exists a constant C such that for all $r, n, k \in \mathbb{N}$:

$$\mathbb{E}_{IIC} \left(\left(\sum_{\substack{x, y \in \mathcal{C}(0) \cap Q_r \\ |x-y| \leq k}} 1 \right)^n \right) \leq C^{2n} \cdot \frac{(4n)!}{4^n \cdot (2n)!} \cdot r^{4n} \cdot k^{4n}.$$

Corollary 2.12 is important for the (conditional) lower bound on the discrete Hausdorff dimension of the IIC, discussed in Theorem 5.12. Corollary 2.11 is in particular interesting for the case $n = 2$, because of its application in the proof of Theorem 1.14. In general it serves as an intuition for the exact value of the moments $\mathbb{E}_{IIC}(|X_r|^n)$, leading to the conditional bounds on the mass dimension of the IIC in subsection 3.2.

Corollary 2.13

For all $n \in \mathbb{N}$ there exist constants C'_n and C_n such that for all r :

$$C'_n \leq \frac{\mathbb{E}_{IIC}(|X_r|^n)}{\mathbb{E}_{IIC}(|X_r|)^n} \leq C_n.$$

Proof. The right bound is Corollary 2.11. The left bound follows from Jensen's inequality because $x \mapsto x^n$ is a convex function on $\mathbb{R}_{\geq 0}$. \square

Conjecture 2.14

For all $n \in \mathbb{N}$ there exists a constant C_n , perhaps equal to $\frac{(2n)!}{2^n \cdot n!}$, such that

$$\lim_{r \rightarrow \infty} \frac{\mathbb{E}_{IIC}(|X_r|^n)}{\mathbb{E}_{IIC}(|X_r|)^n} = C_n.$$

Due to the generality of the statement of Theorem 2.10, its proof is rather complex and difficult to read. Therefore we have also included the simpler proof for the case $n = 2$ of Corollary 2.11, to boost the intuition of the reader (see Lemma 2.16). It is advisable to read that first.

In order to prove the general Theorem 2.10 we need the following Lemma.

Lemma 2.15

Let T be a tree diagram on the $2m + n + 2$ labeled vertices $0, x_1, \dots, x_{2m+n}, \alpha$. Let T^* denote the reduced tree diagram obtained by deleting α from T , along with the edge that is connected to α . Then it holds for all $k_1, \dots, k_m \in \mathbb{N}$ and all $r_1, \dots, r_m, \dots, r_{m+n} \in \mathbb{N}$ that

$$\Sigma^* := \sum_{\substack{x_1, x_2 \in Q_{r_1}, \dots, x_{2m-1}, x_{2m} \in Q_{r_m} \\ x_{2m+1} \in Q_{r_{m+1}}, \dots, x_{2m+n} \in Q_{r_{m+n}} \\ \text{such that} \\ |x_{2i} - x_{2i-1}| \leq k_i \text{ for all } i \in \{1, \dots, m\}}} \sum_{z_1, \dots, z_{2m+n} \in \mathbb{Z}^d} \prod_{\substack{(v,w) \text{ in } T^* \\ v, w \in \{x_1, \dots, x_{(2m+n)}, z_1, \dots, z_{(2m+n)}, 0\}}} \tau(v-w),$$

where the product is over all edges (v, w) that are in T^* , is bounded above by

$$C^{2m+n} \cdot \prod_{i=1}^m k_i^4 \cdot \prod_{i=1}^{m+n} r_i^4.$$

Here C again denotes the maximum of the constants appearing in Lemma 2.5 and 2.7.

Proof. The proof is with induction and is build upon repeatedly applying Lemma 2.5 and 2.7. Each application to T^* of any one of these Lemmas graphically amounts to removing two edges and two vertices (one labeled external vertex and one unlabeled internal vertex) from T^* , thus yielding a smaller reduced tree diagram. For $n = m = 0$ the reduced tree diagram T^* consists only of the vertex 0. In this case it is natural to set $\Sigma^* = 1$ and claim that the lemma is true for $n + 2m = 0$,

but to make our induction proof completely rigorous we actually need to show the lemma holds if $n + 2m = 1$. We will postpone this and first explain the induction step.

Let $N \in \mathbb{N}$ and assume that the bound holds for all $m, n \in \mathbb{N}$ with $n + 2m < N$. To show: the bound also holds for all $m, n \in \mathbb{N}$ with $n + 2m = N$.

The main observation is that any reduced tree diagram involving labeled external vertices $\{0, x_1, \dots, x_{2m+n}\}$ can be constructed from a reduced tree diagram involving only external vertices $\{0, x_1, \dots, x_{2m+n}\} \setminus \{x_{add}\}$, for some $x_{add} \in \{0, x_1, \dots, x_{2m+n}\}$. This can be done using one of the three procedures depicted in Figure 5. Figure 5a represents an application of Lemma 2.5, while Figure 5b represents an application of Lemma 2.7. These constructions are sufficient, because any reduced tree diagram with ≥ 2 labeled vertices is of the form of at least one of the RHS pictures in Figure 5. Note that in all cases we can identify not only an external node x_{add} , but also a corresponding internal node $z_{add} \in \mathbb{Z}^d$.

Case 1: as in Figure 5a.

Before we start to estimate Σ^* , we need to discern two subcases, regarding the nature of x_{add} , which must equal x_i for some $i \in \{1, \dots, 2m+n\}$. In case $i \in \{1, \dots, 2m\}$, there is an additional constraint: there exist a vertex x_0 in T^* and an integer k_{add} such that $|x_{add} - x_0| \leq k_{add}$. Let's address this situation first.

Case 1.1: x_{add} is constrained

In the derivation below $\sum_{(\dots)}$ denotes [summation over $z_1, \dots, z_{(2m+n)} \in \mathbb{Z}^d$, excluding the summation over $z_{add} \in \mathbb{Z}^d$], combined with [summation over $x_1, x_2 \in Q_{r_1}, \dots, x_{2m-1}, x_{2m} \in Q_m, x_{2m+1} \in Q_{r_{2m+1}}, \dots, x_{2m+n} \in Q_{r_{2m+n}}$, excluding the summation over $x_{add} \in Q_{r_{add}}$], under the constraints $[|x_{2i} - x_{2i-1}| \leq k_i \text{ for all } i \in \{1, \dots, m\}]$, excluding the constraint $|x_{add} - x_0| \leq k_{add}$. Furthermore:

$$\prod_{(\dots)} \quad \text{denotes} \quad \prod_{\substack{(v,w) \text{ in } T^* \\ v,w \in \{x_1, \dots, x_{(2m+n)}, z_1, \dots, z_{(2m+n)}, 0\} \setminus \{x_{add}, z_{add}\}}} .$$

Using this notation we reorder the terms in Σ^* and then eliminate the dependency on z_0 by the uniform estimate provided by Lemma 2.5:

$$\begin{aligned} \Sigma^* &= \sum_{(\dots)} \left(\left(\prod_{(\dots)} \tau(v-w) \right) \cdot \sum_{\substack{x_{add} \in Q_{r_{add}} \\ |x_{add} - x_0| \leq k_{add}}} \sum_{z_{add} \in \mathbb{Z}^d} \tau(x_{add} - z_{add}) \cdot \tau(z_{add} - z_0) \right) \\ &= \sum_{(\dots)} \left(\left(\prod_{(\dots)} \tau(v-w) \right) \cdot \delta_{(k_{add}, r_{add})}(z_0, x_0) \right) \\ &\stackrel{\text{Lemma 2.5}}{\leq} \sum_{(\dots)} \left(\prod_{(\dots)} \tau(v-w) \right) \cdot C \cdot k_{add}^4 \\ &= \Sigma^{**} \cdot C \cdot k_{add}^4. \end{aligned} \tag{2.17}$$

Here Σ^{**} denotes the sum corresponding to the tree diagram T^{**} one obtains by removing the vertices x_{add} and z_{add} and the corresponding edges $x_{add} \leftrightarrow z_{add}$ and $z_{add} \leftrightarrow z_0$ from T^* . Note that the vertex x_0 has been set free; it has become an ordinary vertex in $Q_{r_{add}}$; no longer suffering from a constraint of the form $|x_i - x_0| \leq k_i$. So T^{**} has $2(m-1)$ constrained vertices and $n+1$ unconstrained vertices.

By the induction hypothesis $\Sigma^{**} \leq C^{2(m-1)+(n+1)} \cdot \left(\frac{1}{k_{add}^4} \prod_{i=1}^m k_i^4\right) \left(\prod_{i=1}^{m+n} r_i^4\right)$. So the desired bound emerges: $\Sigma^* \leq C^{2m+n} \cdot \prod_{i=1}^m k_i^4 \cdot \prod_{i=1}^{m+n} r_i^4$.

Case 1.2: x_{add} is not constrained

This can be interpreted as a special case of Case 1.1. By assumption the vertex x_{add} is already

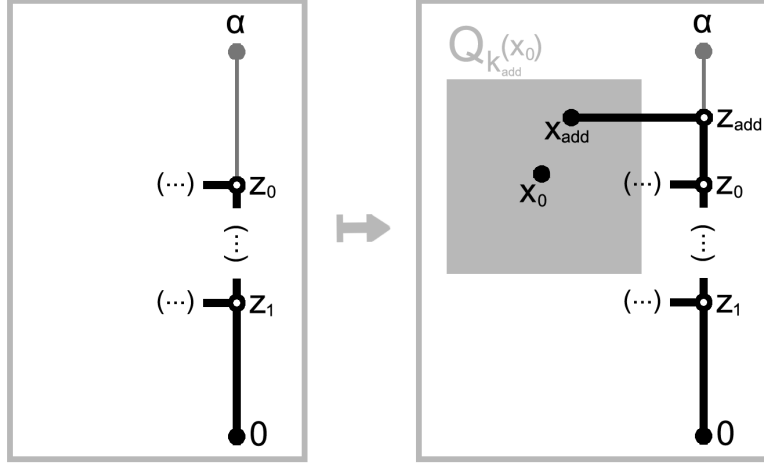

(a) In this case z_{add} lies on the unique edge that is connected to α in the original (not reduced) tree diagram, depicted on the left.

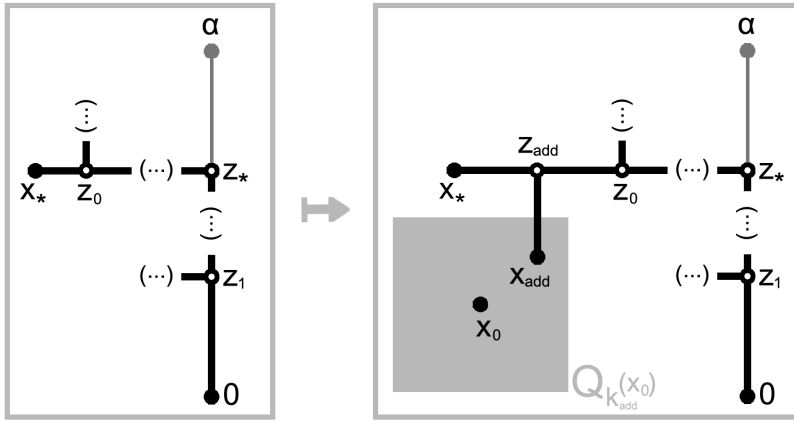

(b) In this case z_{add} lies on an edge that is *not* the edge that is connected to α in the original (not reduced) tree diagram, depicted on the left.

Figure 5: Given a reduced tree diagram on N labeled vertices (Right Hand Sides) we can restore the original tree diagram on $N + 1$ labeled vertices by adding vertex α and its adjacent (grey) edge. In this tree diagram we can always identify an internal vertex z_{add} and an external labeled vertex x_{add} such that z_{add} is connected to at least 2 external vertices (either x_{add} and x_* or x_{add} and α). Removing x_{add}, z_{add} and α and their adjacent edges now yields a reduced tree diagram on $N - 1$ labeled vertices (Left Hand Sides). In case (a), the contribution of x_{add} and z_{add} to Σ^* can be estimated using Lemma 2.5 (in case we have the additional restriction that $|x_{add} - x_0| \leq k_{add}$) or Corollary 2.6 (without that restriction), while in case (b) and (c) the contribution of x_{add} and z_{add} can be estimated using Lemma 2.7 (in case of the additional restriction $|x_{add} - x_0| \leq k_{add}$) or Corollary 2.8 (without that restriction). Remark: the symbols z_1 and z_* in these pictures are not important for our calculations; they just denote some internal vertices.

‘free’, so we can remove the restriction $|x_{add} - x_0| \leq k_{add}$ in derivation (2.17) and apply Corollary 2.6 to obtain:

$$\begin{aligned}
\Sigma^* &= \sum_{(\dots)} \left(\left(\prod_{(\dots)} \tau(v-w) \right) \cdot \sum_{x_{add} \in Q_{r_{add}}} \sum_{z_{add} \in \mathbb{Z}^d} \tau(x_{add} - z_{add}) \cdot \tau(z_{add} - z_0) \right) \\
&= \sum_{(\dots)} \left(\left(\prod_{(\dots)} \tau(v-w) \right) \cdot \delta_{(\infty, r_{add})}(z_0, 0) \right) \\
&\stackrel{\text{Corollary 2.6}}{\leq} \sum_{(\dots)} \left(\prod_{(\dots)} \tau(v-w) \right) \cdot C \cdot r_{add}^4 \\
&= \Sigma^{**} \cdot C \cdot r_{add}^4. \tag{2.18}
\end{aligned}$$

In this case the new diagram T^{**} has $2m$ constrained vertices and $n-1$ unconstrained vertices. So by the induction hypothesis: $\Sigma^{**} \leq C^{2m+(n-1)} \cdot \left(\prod_{i=1}^m k_i^4 \right) \left(\frac{1}{r_{add}^4} \cdot \prod_{i=1}^{m+n} r_i^4 \right)$. So again the desired bound emerges: $\Sigma^* \leq C^{2m+n} \cdot \prod_{i=1}^m k_i^4 \cdot \prod_{i=1}^{m+n} r_i^4$.

Case 2: as in Figure 5b.

The proof structure is the same as in case 1. The most important difference is that we apply Lemma 2.7 (resp. Corollary 2.8) instead of Lemma 2.5 (resp. Corollary 2.6).

Case 2.1: x_{add} is constrained

Instead of the derivation in (2.17) comes the following

$$\begin{aligned}
\Sigma^* &= \sum_{(\dots)} \left(\left(\prod_{(\dots)} \tau(v-w) \right) \cdot \sum_{\substack{x_{add} \in Q_{r_{add}} \\ x^* \in Q_{r^*} \\ |x_{add} - x_0| \leq k_{add}}} \sum_{z_{add} \in \mathbb{Z}^d} \tau(x_{add} - z_{add}) \cdot \tau(z_{add} - x^*) \cdot \tau(z_{add} - z_0) \right) \\
&= \sum_{(\dots)} \left(\left(\prod_{(\dots)} \tau(v-w) \right) \cdot \eta_{(k_{add}, r^*, r_{add})}(z_0, x_0) \right) \\
&\stackrel{\text{Lemma 2.7}}{\leq} \sum_{(\dots)} \left(\prod_{(\dots)} \tau(v-w) \right) \cdot C \cdot k_{add}^4 \cdot \sum_{x^* \in Q_{r^*}} \tau(z_0 - x^*) \\
&= \Sigma^{**} \cdot C \cdot k_{add}^4. \tag{2.19}
\end{aligned}$$

where Σ^{**} in this case denotes the sum corresponding to the tree diagram T^{**} one obtains by removing from T^* the vertices x_{add} and z_{add} as well as the corresponding edges $x^* \leftrightarrow z_{add}$, $x_{add} \leftrightarrow z_{add}$ and $z_{add} \leftrightarrow z_0$, while adding the edge $z_0 \leftrightarrow x^*$.

This is not entirely correct yet, because we have to pay a little more attention if the labeled vertices x^* and x_0 coincide: in that case $\eta_{(k_{add}, r^*, r_{add})}(z_0, x_0)$ must be replaced by $\eta_{(k_{add}, r^*, r_{add})}(z_0)$ in the second equality. Lemma 2.7 then still provides the (same) upper bound.

Case 2.2: x_{add} is not constrained

The derivation in (2.18) must be replaced by:

$$\begin{aligned}
\Sigma^* &= \sum_{(\dots)} \left(\left(\prod_{(\dots)} \tau(v-w) \right) \cdot \sum_{\substack{x_{add} \in Q_{r_{add}} \\ x^* \in Q_{r^*}}} \sum_{z_{add} \in \mathbb{Z}^d} \tau(x_{add} - z_{add}) \cdot \tau(z_{add} - x^*) \cdot \tau(z_{add} - z_0) \right) \\
&= \sum_{(\dots)} \left(\left(\prod_{(\dots)} \tau(v-w) \right) \cdot \eta_{(\infty, r^*, r_{add})}(z_0, 0) \right) \\
&\stackrel{\text{Corollary 2.8}}{\leq} \sum_{(\dots)} \left(\prod_{(\dots)} \tau(v-w) \right) \cdot C \cdot r_{add}^4 \cdot \sum_{x^* \in Q_{r^*}} \tau(z_0 - x^*) \\
&= \Sigma^{**} \cdot C \cdot r_{add}^4. \tag{2.20}
\end{aligned}$$

Now we have considered all possible subcases, so the proof of the induction step is finished.

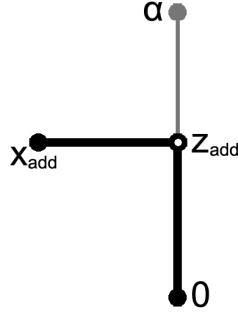

Figure 6: *Initial condition tree diagram.*

To complete the induction proof, it remains to clarify that the lemma also holds for the initial condition (if $n + 2m = 1$). If $n + 2m = 1$ then $n = 1$. So, including the 0 vertex, the reduced tree diagram has 2 labeled vertices and one unlabeled internal vertex. There is only one such reduced tree diagram, shown in Figure 6. Bounding this diagram amounts to the same derivations as in (2.18), with the only two differences that $z_0 = 0$ (instead of an arbitrary point in \mathbb{Z}^d) and the terms $\sum_{(\dots)}$, $\prod_{(\dots)}$ and Σ^{**} are left out. Explicitly:

$$\Sigma^* = \sum_{x_{add} \in Q_{r_{add}}} \sum_{z_{add} \in \mathbb{Z}^d} \tau(x_{add} - z_{add}) \cdot \tau(z_{add} - 0) = \delta_{(\infty, r_{add})}(0, 0) \leq C \cdot r_{add}^4.$$

□

We are ready to prove the main theorem.

Proof of Theorem 2.10

$$\begin{aligned}
& \mathbb{E}_{IIC} \left(\prod_{i=1}^m \left(\sum_{\substack{x,y \in \mathcal{C}(0) \cap Q_{r_i} \\ |x-y| \leq k_i}} 1 \right) \cdot \prod_{i=m+1}^{m+n} \left(\sum_{x \in \mathcal{C}(0) \cap Q_{r_i}} 1 \right) \right) \\
&= \mathbb{E}_{IIC} \left(\prod_{i=1}^m \left(\sum_{\substack{x,y \in Q_{r_i} \\ |x-y| \leq k_i}} \mathbb{1}_{0 \leftrightarrow x, 0 \leftrightarrow y} \right) \cdot \prod_{i=m+1}^{m+n} \left(\sum_{x \in Q_{r_i}} \mathbb{1}_{0 \leftrightarrow x} \right) \right) \\
&= \mathbb{E}_{IIC} \left(\sum_{\substack{x_1, x_2 \in Q_{r_1}, \dots, x_{2m-1}, x_{2m} \in Q_{r_m} \\ x_{2m+1} \in Q_{r_{m+1}}, \dots, x_{2m+n} \in Q_{r_{m+n}} \\ \text{such that} \\ |x_{2i} - x_{2i-1}| \leq k_i \text{ for all } i \in \{1, \dots, m\}}} \prod_{i=1}^{2m+n} \mathbb{1}_{0 \leftrightarrow x_i} \right) \\
&= \sum_{\substack{x_1, x_2 \in Q_{r_1}, \dots, x_{2m-1}, x_{2m} \in Q_{r_m} \\ x_{2m+1} \in Q_{r_{m+1}}, \dots, x_{2m+n} \in Q_{r_{m+n}} \\ \text{such that} \\ |x_{2i} - x_{2i-1}| \leq k_i \text{ for all } i \in \{1, \dots, m\}}} \mathbb{P}_{IIC} \left(\bigcap_{i=1}^{2m+n} \mathbb{1}_{0 \leftrightarrow x_i} \right) \\
&= \lim_{p \uparrow p_c} \frac{1}{\chi_p} \sum_{\substack{x_1, x_2 \in Q_{r_1}, \dots, x_{2m-1}, x_{2m} \in Q_{r_m} \\ x_{2m+1} \in Q_{r_{m+1}}, \dots, x_{2m+n} \in Q_{r_{m+n}} \\ \text{such that} \\ |x_{2i} - x_{2i-1}| \leq k_i \text{ for all } i \in \{1, \dots, m\}}} \sum_{\alpha \in \mathbb{Z}^d} \mathbb{P}_p \left(\bigcap_{s \in \{x_1, \dots, x_{2m+n}, \alpha\}} (0 \leftrightarrow s) \right). \quad (2.21)
\end{aligned}$$

We proceed by bounding the sum in (2.21). For the vertices in $\{0, x_1, \dots, x_{2m+n}, \alpha\}$ to be connected, there has to be an unrooted binary tree that connects those $2m+n+2$ labeled vertices. By definition (see Lemma 2.9) there are $\mathcal{T}(2m+n)$ of such tree diagrams. Let T_j denote the j -th tree diagram with respect to some ordering. Then:

$$\sum_{\alpha \in \mathbb{Z}^d} \mathbb{P}_p \left(\bigcap_{s \in \{x_1, \dots, x_{2m+n}, \alpha\}} (0 \leftrightarrow s) \right) \leq \sum_{j=1}^{\mathcal{T}_{2m+n}} \sum_{z_1, \dots, z_{2m+n}, \alpha \in \mathbb{Z}^d} \mathbb{P}_p \left(\begin{array}{l} \text{all vertices that are connected by an} \\ \text{edge in the unrooted binary tree } T_j \\ \text{(that has external vertices } 0, x_1, \dots, x_{2m+n}, \alpha \\ \text{and internal vertices } z_1, \dots, z_{2m+n}) \\ \text{are disjointly connected in } \mathbb{Z}^d \end{array} \right)$$

By the BK-inequality the probability in the sum on the right hand side is bounded above by

$$\prod_{\substack{(v,w) \text{ in } T_j \\ v, w \in \{0, x_1, \dots, x_{2m+n}, z_1, \dots, z_{2m+n}, \alpha\}}} \mathbb{P}_p(v \leftrightarrow w). \quad (2.22)$$

Let T_j^* denote the reduced tree diagram one obtains by deleting from T_j the vertex α and the (unique) edge that connects α to some internal node z_α . Using this notation we can rewrite (2.22) in such a way that it becomes clear that $\chi(p) := \sum_{\alpha \in \mathbb{Z}^d} \mathbb{P}_p(\alpha \leftrightarrow 0)$ can be divided out from (2.21), which in turn allows for taking the limit $p \uparrow p_c$:

$$\begin{aligned}
\lim_{p \uparrow p_c} \frac{1}{\chi(p)} \sum_{\alpha \in \mathbb{Z}^d} (2.22) &= \lim_{p \uparrow p_c} \frac{1}{\chi(p)} \sum_{\alpha \in \mathbb{Z}^d} \mathbb{P}_p(\alpha \leftrightarrow z_\alpha) \cdot \prod_{\substack{(v,w) \text{ in } T_j^* \\ v,w \in \{0,x_1,\dots,x_{2m+n},z_1,\dots,z_{2m+n}\}}} \mathbb{P}_p(v \leftrightarrow w) \\
&= \prod_{\substack{(v,w) \text{ in } T_j^* \\ v,w \in \{0,x_1,\dots,x_{2m+n},z_1,\dots,z_{2m+n}\}}} \tau(v-w) \tag{2.23}
\end{aligned}$$

Combining everything yields:

$$\begin{aligned}
(2.21) &\leq \lim_{p \uparrow p_c} \frac{1}{\chi_p} \left(\sum_{\substack{x_1, x_2 \in Q_{r_1}, \dots, x_{2m-1}, x_{2m} \in Q_{r_m} \\ x_{2m+1} \in Q_{r_{m+1}}, \dots, x_{2m+n} \in Q_{r_{m+n}} \\ \text{such that} \\ |x_{2i} - x_{2i-1}| \leq k_i \text{ for all } i \in \{1, \dots, m\}}} \sum_{j=1}^{\mathcal{T}_{2m+n}} \sum_{z_1, \dots, z_{2m+n}, \alpha \in \mathbb{Z}^d} (2.22) \right) \\
&\stackrel{(2.23)}{=} \sum_{j=1}^{\mathcal{T}_{2m+n}} \left(\sum_{\substack{x_1, x_2 \in Q_{r_1}, \dots, x_{2m-1}, x_{2m} \in Q_{r_m} \\ x_{2m+1} \in Q_{r_{m+1}}, \dots, x_{2m+n} \in Q_{r_{m+n}} \\ \text{such that} \\ |x_{2i} - x_{2i-1}| \leq k_i \text{ for all } i \in \{1, \dots, m\}}} \sum_{z_1, \dots, z_{2m+n} \in \mathbb{Z}^d} \prod_{\substack{(v,w) \text{ in } T_j^* \\ v,w \in \{0,x_1,\dots,x_{2m+n},z_1,\dots,z_{2m+n}\}}} \tau(v-w) \right).
\end{aligned}$$

At this point all efforts converge because we can finally apply the most important, hard-fought and ugliest lemma of this section. Indeed: Lemma 2.15 bounds all of the terms inside the sum $\sum_{j=1}^{\mathcal{T}_{2m+n}} (\dots)$ by the same factor, yielding:

$$(2.21) \leq \mathcal{T}_{2m+n} \cdot C^{2m+n} \cdot \prod_{i=1}^m k_i^4 \cdot \prod_{i=1}^{m+n} r_i^4.$$

□

2.3 Relatively intuitive and readable proof that $\mathbb{E}_{IIC}(|X_r|^2) \leq C \cdot r^2$

Lemma 2.16

There exists a constant C such that for all r :

$$\mathbb{E}_{IIC}(|X_r|^2) \leq C \cdot \mathbb{E}_{IIC}(|X_r|)^2.$$

Proof. By Theorem 1.9 it suffices to show that $\mathbb{E}_{IIC}(|X_r|^2) = \mathcal{O}(r^8)$. Note that

$$\mathbb{E}_{IIC}(|X_r|^2) = \mathbb{E}_{IIC} \left(\left(\sum_{x \in Q_r} \mathbb{1}_{0 \leftrightarrow x} \right)^2 \right) = \mathbb{E}_{IIC} \left(\sum_{x, y \in Q_r} \mathbb{1}_{0 \leftrightarrow x, 0 \leftrightarrow y} \right) = \sum_{x, y \in Q_r} \mathbb{P}_{IIC}(0 \leftrightarrow x, 0 \leftrightarrow y),$$

so by construction (1.5) of the IIC-measure:

$$\mathbb{E}_{IIC}(|X_r|^2) = \lim_{p \uparrow p_c} \frac{1}{\chi_p} \sum_{x, y \in Q_r} \sum_{\alpha \in \mathbb{Z}^d} \mathbb{P}_p(0 \leftrightarrow x, 0 \leftrightarrow y, 0 \leftrightarrow \alpha).$$

For the four points $0, x, y$ and α to be connected there has to be a connecting tree, so we can bound this from above by three sums, which are represented by the diagrams in Figure 7. That is: $\mathbb{E}_{IIC}(|X_r|^2) \leq \Sigma_1 + \Sigma_2 + \Sigma_3$, where

$$\begin{aligned} \Sigma_1 &= \lim_{p \uparrow p_c} \frac{1}{\chi_p} \sum_{x, y \in Q_r} \sum_{z_1, z_2, \alpha \in \mathbb{Z}^d} \mathbb{P}_p(0 \leftrightarrow z_1 \circ z_1 \leftrightarrow x \circ z_1 \leftrightarrow z_2 \circ z_2 \leftrightarrow y \circ z_2 \leftrightarrow \alpha) \\ \Sigma_2 &= \lim_{p \uparrow p_c} \frac{1}{\chi_p} \sum_{x, y \in Q_r} \sum_{z_1, z_2, \alpha \in \mathbb{Z}^d} \mathbb{P}_p(0 \leftrightarrow z_1 \circ z_1 \leftrightarrow y \circ z_1 \leftrightarrow z_2 \circ z_2 \leftrightarrow x \circ z_2 \leftrightarrow \alpha) \\ \Sigma_3 &= \lim_{p \uparrow p_c} \frac{1}{\chi_p} \sum_{x, y \in Q_r} \sum_{z_1, z_2, \alpha \in \mathbb{Z}^d} \mathbb{P}_p(0 \leftrightarrow z_1 \circ z_1 \leftrightarrow z_2 \circ z_2 \leftrightarrow x \circ z_2 \leftrightarrow y \circ z_1 \leftrightarrow \alpha). \end{aligned}$$

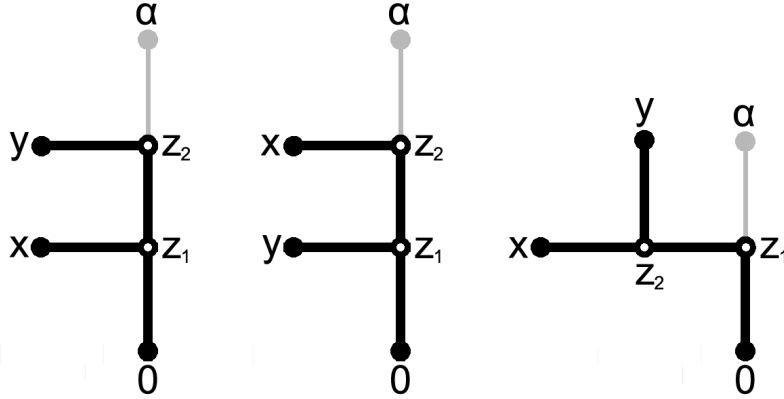

Figure 7: From left to right: the tree diagrams corresponding to the sums Σ_1, Σ_2 and Σ_3 .

The sums Σ_1 and Σ_2 are equal so we only have to estimate Σ_1 and Σ_3 . The BK-inequality helps to get rid of the limit and the factor χ_p :

$$\begin{aligned} \Sigma_1 &\leq \lim_{p \uparrow p_c} \frac{\sum_{x, y \in Q_r} \sum_{z_1, z_2 \in \mathbb{Z}^d} \mathbb{P}_p(0 \leftrightarrow z_1) \cdot \mathbb{P}_p(z_1 \leftrightarrow x) \cdot \mathbb{P}_p(z_1 \leftrightarrow z_2) \cdot \mathbb{P}_p(z_2 \leftrightarrow y) \cdot \sum_{\alpha \in \mathbb{Z}^d} \mathbb{P}_p(z_2 \leftrightarrow \alpha)}{\sum_{\alpha \in \mathbb{Z}^d} \mathbb{P}_p(0 \leftrightarrow \alpha)} \\ &= \sum_{x, y \in Q_r} \sum_{z_1, z_2 \in \mathbb{Z}^d} \tau(z_1) \cdot \tau(x - z_1) \cdot \tau(z_2 - z_1) \cdot \tau(y - z_2). \end{aligned}$$

Similarly:

$$\Sigma_3 \leq \sum_{x, y \in Q_r} \sum_{z_1, z_2 \in \mathbb{Z}^d} \tau(z_1) \cdot \tau(z_2 - z_1) \cdot \tau(x - z_2) \cdot \tau(y - z_2).$$

We first proceed with the estimate on Σ_1 by reordering the sum, thus essentially separating the diagram corresponding to Σ_1 in two smaller diagrams.

$$\Sigma_1 \leq \sum_{x \in Q_r} \sum_{z_1 \in \mathbb{Z}^d} \tau(z_1) \cdot \tau(x - z_1) \cdot A(z_1)$$

where

$$\begin{aligned} A(z_1) &:= \sum_{y \in Q_r} \sum_{z_2 \in \mathbb{Z}^d} \tau(z_2 - z_1) \cdot \tau(y - z_2) \\ &= \sum_{y \in Q_r} \sum_{z_2 \in \mathbb{Z}^d} \tau(z_2) \cdot \tau(y - z_1 - z_2) \\ &= \sum_{y \in Q_r} (\tau * \tau)(y - z_1) \\ &= \mathcal{O}(r^4). \end{aligned}$$

The final equality follows from Lemma 2.4 (ii).

Since $A(z_1)$ is bounded by a term that is independent of z_1 it now suffices to bound $\sum_{x \in Q_r} \sum_{z_1 \in \mathbb{Z}^d} \tau(z_1) \cdot \tau(x - z_1)$. But this equals $\sum_{x \in Q_r} (\tau * \tau)(x)$ which, again by Lemma 2.4(ii), is $\mathcal{O}(r^4)$. Thus $\Sigma_1 = \mathcal{O}(r^4 \cdot r^4) = \mathcal{O}(r^8)$, as desired.

Bounding Σ_3 is slightly more complicated.

$$\begin{aligned} \Sigma_3 &\leq \sum_{z_2 \in \mathbb{Z}^d} \left(\left(\sum_{x \in Q_r} \tau(x - z_2) \right) \cdot \left(\sum_{y \in Q_r} \tau(y - z_2) \right) \cdot \sum_{z_1 \in \mathbb{Z}^d} \tau(z_1) \cdot \tau(z_2 - z_1) \right) \\ &= \sum_{z_2 \in \mathbb{Z}^d} \left(\left(\sum_{x \in Q_r} \tau(x - z_2) \right)^2 \cdot (\tau * \tau)(z_2) \right). \end{aligned}$$

We split this in a sum over $z_2 \in Q_{2r}$ and a sum over the remaining points in \mathbb{Z}^d , denoted by $z_2 \notin Q_{2r}$. The estimate of the first sum needs Lemma 2.4(i) and (ii):

$$\begin{aligned} \sum_{z_2 \in Q_{2r}} \left(\left(\sum_{x \in Q_r} \tau(x - z_2) \right)^2 \cdot (\tau * \tau)(z_2) \right) &\leq C' \cdot \left(\sum_{x \in Q_r} \tau(x) \right)^2 \cdot \sum_{z_2 \in Q_{2r}} (\tau * \tau)(z_2) \\ &= \mathcal{O}((r^2)^2 \cdot r^4) \\ &= \mathcal{O}(r^8). \end{aligned}$$

For the other sum we use Lemma 2.4(i) and (iii):

$$\begin{aligned} \sum_{z_2 \notin Q_{2r}} \left(\left(\sum_{x \in Q_r} \tau(x - z_2) \right)^2 \cdot (\tau * \tau)(z_2) \right) &\leq C' \cdot \sum_{z_2 \notin Q_{2r}} (r^d \cdot \tau(z_2))^2 \cdot (\tau * \tau)(z_2) \\ &\leq C'' \cdot r^{2d} \cdot \sum_{z_2 \notin Q_{2r}} \left(\frac{1}{|z|^{d-2}} \right)^2 \cdot \frac{1}{|z|^{d-4}} \\ &= C'' \cdot r^{2d} \cdot \sum_{z_2 \notin Q_{2r}} \frac{1}{|z|^{3d-8}} \\ &\leq C''' \cdot r^{2d} \cdot \frac{1}{r^{2d-8}} \\ &= \mathcal{O}(r^8). \end{aligned}$$

Thus $\Sigma_3 = \mathcal{O}(r^8)$. So, in conclusion: $\mathbb{E}_{IC}(|X_r|^2) = \mathcal{O}(\Sigma_1 + \Sigma_2 + \Sigma_3) = \mathcal{O}(r^8 + r^8 + r^8) = \mathcal{O}(r^8)$. \square

3 Using moment bounds

3.1 Using moment bounds, Markov's inequality and Borel-Cantelli for bounds on the (upper mass) dimension

Lemma 3.1

Let Z_1, Z_2, \dots be a sequence of random variables with values in $\mathbb{R}_{>0}$. Let $g(k)$ be a positive sequence such that $\lim_{k \rightarrow \infty} g(k) = \infty$. Define $r_k := \lfloor k^{g(k)} \rfloor$.

(i) If there exist constants $\beta, C > 0$ such that at least one of the following two conditions holds

- $\mathbb{E}(Z_r) \leq C \cdot r^\beta$ for all $r > 0$.
- $\mathbb{P}(Z_r \geq \lambda \cdot r^\beta) \leq C \cdot \frac{1}{\lambda}$ for all $\lambda, r > 0$.

Then:

$$\mathbb{P} \left(\limsup_{k \rightarrow \infty} (\log_{r_k}(Z_{r_k})) \leq \beta \right) = 1. \quad (3.1)$$

(ii) If there exist constants $\alpha, C' > 0$ such that at least one of the following two conditions holds

- $\mathbb{E} \left(\frac{1}{Z_r} \right) \leq C' \cdot r^{-\alpha}$ for all $r > 0$.
- $\mathbb{P}(Z_r \leq \frac{1}{\lambda} \cdot r^\alpha) \leq C' \cdot \frac{1}{\lambda}$ for all $\lambda, r > 0$.

Then:

$$\mathbb{P} \left(\liminf_{k \rightarrow \infty} (\log_{r_k}(Z_{r_k})) \geq \alpha \right) = 1. \quad (3.2)$$

Proof. We use the notation $Y_r := \log_r(Z_r)$. First we prove (3.1). Apply Markov's inequality (for the first condition) or set $\lambda = r^\epsilon$ (for the second condition) to conclude that for any $\epsilon > 0$ and $r > 0$:

$$\mathbb{P}(Z_r \geq r^{\beta+\epsilon}) \leq \frac{\mathbb{E}(Z_r)}{r^{\beta+\epsilon}} \leq C \cdot \frac{1}{r^\epsilon}.$$

Now

$$Z_r \geq r^{\beta+\epsilon} \iff Y_r \geq \log_r(r^{\beta+\epsilon}) = \beta + \epsilon.$$

So for all $\epsilon > 0$ and all r :

$$\mathbb{P}(Y_r - \beta \geq \epsilon) \leq C \cdot \frac{1}{r^\epsilon}.$$

Now we come to the more interesting part of the proof. Let $\mu > 0$ and consider the sequence $\epsilon_k = \frac{1+\mu}{g(k)} \downarrow 0$. Then

$$\mathbb{P}(Y_{r_k} - \beta \geq \epsilon_k) \leq C \cdot r_k^{-\epsilon_k} \leq C \cdot (k^{g(k)})^{-\epsilon_k} = C \cdot k^{\frac{-g(k)(1+\mu)}{g(k)}} = \frac{C}{k^{1+\mu}}. \quad (3.3)$$

So

$$\sum_{k=1}^{\infty} \mathbb{P}(Y_{r_k} - \beta \geq \epsilon_k) \leq \sum_{k=1}^{\infty} \frac{C}{k^{1+\mu}} < \infty.$$

This means we can apply Borel-Cantelli, which implies:

$$\mathbb{P}(Y_{r_k} - \beta \geq \epsilon_k \text{ i.o.}) = 0$$

So with probability 1: $Y_{r_k} - \beta \leq \epsilon_k$ for all k large enough. Id est:

$$\mathbb{P} \left(\limsup_{k \rightarrow \infty} (Y_{r_k}) \leq \beta \right) = 1. \quad (3.4)$$

This finishes the proof of (3.1). For (3.2) almost the same argument works, because

$$\mathbb{P}(Y_r - \alpha \leq -\epsilon) = \mathbb{P}(Z_r \leq r^{\alpha-\epsilon}) = \mathbb{P}\left(\frac{1}{Z_r} \geq r^{-\alpha+\epsilon}\right) \leq \frac{\mathbb{E}\left(\frac{1}{Z_r}\right)}{r^{-\alpha+\epsilon}} \leq C' \cdot \frac{1}{r^\epsilon}$$

holds for all $\epsilon > 0$ and all r . By the arguments used in (3.3) - (3.4) we obtain

$$\mathbb{P}(Y_{r_k} - \alpha \leq -\epsilon_k \text{ i.o.}) = 0$$

so with probability 1: $Y_{r_k} - \alpha \geq -\epsilon_k$ for all k large enough. That is:

$$\mathbb{P}\left(\liminf_{k \rightarrow \infty} (Y_{r_k}) \geq \alpha\right) = 1.$$

□

Proof of Theorem 1.10

Proof. Choose some $\sigma \in \mathbb{N}_{>1}$. We use Lemma 3.1, taking $g(k) = \frac{k}{\log_\sigma(k)}$, so that

$$r_k = \lfloor k^{g(k)} \rfloor = \lfloor \sigma^{\log_\sigma(k^{g(k)})} \rfloor = \lfloor \sigma^{g(k) \cdot \log_\sigma(k)} \rfloor = \sigma^k.$$

By Lemma 3.1 we have a.s. convergence on this subsequence r_k :

$$\mathbb{P}(\limsup_{k \rightarrow \infty} Y_{\sigma^k} \leq \beta) = 1 \tag{3.5}$$

holds under the assumptions of (1.12), while under the assumptions of (1.13) we have:

$$\mathbb{P}(\liminf_{k \rightarrow \infty} Y_{\sigma^k} \geq \alpha) = 1 \tag{3.6}$$

As before, the notation $Y_r := \log_r(Z_r)$ is employed. We proceed by using the a.s. convergence on the subsequence $r_k = \sigma^k$ and the assumption that $Z_1 \leq Z_2 \leq \dots$, to show a.s. convergence for all radii r . For a given r choose k such that $\sigma^k \leq r \leq \sigma^{k+1}$. Then

$$Y_r = \frac{\log(Z_r)}{\log(r)} \leq \frac{\log(Z_{\sigma^{k+1}})}{\log(\sigma^k)} = \frac{\log(Z_{\sigma^{k+1}})}{\log(\sigma^{k+1})} \cdot \frac{\log(\sigma^{k+1})}{\log(\sigma^k)} = Y_{\sigma^{k+1}} \cdot \frac{k+1}{k}.$$

and

$$Y_r = \frac{\log(Z_r)}{\log(r)} \geq \frac{\log(Z_{\sigma^k})}{\log(\sigma^{k+1})} = \frac{\log(Z_{\sigma^k})}{\log(\sigma^k)} \cdot \frac{\log(\sigma^k)}{\log(\sigma^{k+1})} = Y_{\sigma^k} \cdot \frac{k}{k+1}.$$

Therefore

$$\limsup_{r \rightarrow \infty} Y_r = \limsup_{k \rightarrow \infty} Y_{\sigma^k} \tag{3.7}$$

and

$$\liminf_{r \rightarrow \infty} Y_r = \liminf_{k \rightarrow \infty} Y_{\sigma^k}. \tag{3.8}$$

Finally: evaluating (3.7) in (3.5) yields (1.12), while evaluating (3.8) in (3.6) yields (1.13). □

Corollary 3.2

$$\mathbb{P}_{IIC}(\limsup_{r \rightarrow \infty} Y_r \leq 4) = 1$$

In other words, we \mathbb{P}_{IIC} -almost surely have:

$$\overline{d}_m(IIC) \leq 4.$$

3.2 Lower bounds on the mass dimension of the IIC, using conjectured moment bounds

In this subsection we introduce a special function (see Lemma 3.3) that can provide us with a lower bound on the mass dimension of a random set. After stating results for quite general random variables, a *conditional* proof that $\mathbb{P}_{IIC}(d_m(IIC) = 4)$ is given in Corollary 3.10.

In section 2 it was derived that there is a constant C such that for all n :

$$\frac{\mathbb{E}_{IIC}(|X_r|^n)}{\mathbb{E}_{IIC}(|X_r|)^n} \leq C^n \cdot \frac{(2n)!}{2^n \cdot n!}.$$

Recall that this upper bound was derived by bounding $\mathbb{E}_{IIC}(|X_r|^n)$ from above by $\frac{(2n)!}{2^n \cdot n!}$ sums of order $\mathbb{E}_{IIC}(|X_r|)$, each of which corresponds to a tree diagram on $n + 2$ vertices. There is good reason to believe that it is possible to derive a comparable lower bound, consisting of sums indexed by the same $\frac{(2n)!}{2^n \cdot n!}$ tree diagrams and each of which is also of order $\mathbb{E}_{IIC}(|X_r|)$. This can be done by the same techniques that were used to derive that $\mathbb{E}_{IIC}(|X_r|) \geq c \cdot r^4$ holds: see [2]. To derive it rigorously for general n would require a massive calculation, involving (infinitely) many bounds, as the technique resembles an application of the principle of inclusion and exclusion. Although it is doable we refrain from doing so because the next step, controlling the constant C , is beyond our possibilities at this moment. Therefore we formulate a conjecture. It is conjectured that for all $n \in \mathbb{N}$:

$$\lim_{r \rightarrow \infty} \frac{\mathbb{E}_{IIC}(|X_r|^n)}{\mathbb{E}_{IIC}(|X_r|)^n} \cdot \frac{2^n \cdot n!}{(2n)!} = 1. \quad (3.9)$$

Inspired by this conjecture we investigate conditions under which $\log_r(|X_r|)$ converges in probability (Corollaries 3.7 and 3.8) or almost surely (Corollary 3.10) to 4. That is: the latter result provides conditions under which the mass dimension of the IIC almost surely equals 4.

Of course it may be that the conjecture is false. In that case this section is not useless, because most results are first stated for general random variables with values in $\mathbb{R}_{\geq 0}$, yielding conditions for weak and almost sure lower bounds on $\frac{Z_r}{\mathbb{E}(Z_r)}$ and $\log_r(Z_r)$.

Motivation for introducing the function in Lemma 3.3.

Given the values of the moments of a random variable Z and the desire to calculate a ‘probabilistic lower bound’ of the form $\mathbb{P}\left(\frac{Z}{\mathbb{E}(Z)} \leq \frac{1}{\lambda}\right) \leq (\dots)$ for some positive λ , it is tempting to try to calculate $\mathbb{E}\left(\frac{1}{\lambda \cdot \frac{Z}{\mathbb{E}(Z)}}\right)$ or $\mathbb{E}\left(\exp\left(-\lambda \cdot \frac{Z}{\mathbb{E}(Z)}\right)\right)$, because $\frac{1}{x}$ and e^{-x} are positive functions on $\mathbb{R}_{>0}$ that are large when x is small and converge to 0 as $x \rightarrow \infty$. These properties typically cause that $\mathbb{P}\left(\frac{Z}{\mathbb{E}(Z)} \leq \frac{1}{\lambda}\right)$ is small whenever $\mathbb{E}\left(\frac{1}{\lambda \cdot \frac{Z}{\mathbb{E}(Z)}}\right)$ and $\mathbb{E}\left(\exp\left(-\lambda \cdot \frac{Z}{\mathbb{E}(Z)}\right)\right)$ are small. For simplicity: let’s temporarily only consider the case $\lambda = 1$. By writing $\mathbb{E}\left(\frac{\mathbb{E}(Z)}{Z}\right) = \mathbb{E}\left(\frac{1}{1 + \left(\frac{Z}{\mathbb{E}(Z)} - 1\right)}\right) = \mathbb{E}\left(\sum_{n=0}^{\infty} (-1)^n \cdot \left(\frac{Z}{\mathbb{E}(Z)} - 1\right)^n\right)$, we already encounter the first problem; the power series expansion of $\frac{1}{1+x}$ doesn’t converge if $|x| > 1$. Trying again with the entire function e^{-x} and naively bringing the expectation inside the sum we obtain $\mathbb{E}\left(\exp\left(-\frac{Z}{\mathbb{E}(Z)}\right)\right) = \mathbb{E}\left(\sum_{n=0}^{\infty} \frac{\left(-\frac{Z}{\mathbb{E}(Z)}\right)^n}{n!}\right) = \sum_{n=0}^{\infty} \frac{(-1)^n}{n!} \frac{\mathbb{E}(Z^n)}{\mathbb{E}(Z)^n}$. But now there is another possible problem; what if - approximately as in conjecture (3.9) - the moments satisfy $\frac{\mathbb{E}(Z^n)}{\mathbb{E}(Z)^n} = \frac{(2n)!}{2^n \cdot n!}$. Then $\sum_{n=0}^{\infty} \frac{(-1)^n}{n!} \frac{\mathbb{E}(Z^n)}{\mathbb{E}(Z)^n} = \sum_{n=0}^{\infty} (-1/2)^n \cdot \binom{2n}{n}$ doesn’t converge; the moments just grow too fast!

To overcome these problems we need an alternative function $g(x)$ which satisfies the following properties:

- It has a power series expansion that converges everywhere on $\mathbb{R}_{\geq 0}$.
- Its power series expansion converges fast enough.
- It is positive and decreasing on $\mathbb{R}_{\geq 0}$ and goes to 0 as $x \rightarrow \infty$.

The following lemma provides such a function.

Lemma 3.3

$$g(x) := \sum_{n=0}^{\infty} \frac{(-1)^n}{(2n+3)!} x^n = \frac{1 - \frac{\sin(\sqrt{x})}{\sqrt{x}}}{x}$$

is positive and decreasing on $\mathbb{R}_{\geq 0}$ and $\lim_{x \rightarrow \infty} g(x) = 0$.

Proof. Since $x - \sin(x) \geq 0$ on $\mathbb{R}_{\geq 0}$, it follows that $g(x^2) = \frac{x - \sin(x)}{x^3}$ is positive on $\mathbb{R}_{\geq 0}$. Because $\frac{d}{dx}g(x^2) = \frac{d}{dx} \frac{x - \sin(x)}{x^3} = \frac{x^3 \cdot (1 - \cos(x)) - (x - \sin(x)) \cdot 3x^2}{x^6} = \frac{3 \sin(x) - x \cos(x) - 2x}{x^4} \leq 0$, $g(x)$ is decreasing on $\mathbb{R}_{\geq 0}$. The series expansion follows from the Taylor series at 0 for the entire function $\sin(x)$. Indeed:
 $g(x^2) = \frac{x - \sin(x)}{x^3} = \frac{x - \sum_{n=0}^{\infty} \frac{(-1)^n}{(2n+1)!} x^{2n+1}}{x^3} = - \sum_{n=1}^{\infty} \frac{(-1)^n}{(2n+1)!} \frac{x^{2n+1}}{x^3} = \sum_{n=0}^{\infty} \frac{(-1)^n}{(2n+3)!} x^{2n}$. \square

Among other things, the next lemma will be used to find conditional *lower* bounds on the mass dimension of the IIC. It will serve the role that the Markov inequality had in Lemma 3.1, where the almost sure *upper* bound on the mass dimension of the IIC was derived.

Lemma 3.4

Let Z be a random variable with values in $\mathbb{R}_{\geq 0}$. Define $\eta(n) := \frac{\mathbb{E}(Z^n)}{\mathbb{E}(Z)^n}$. If

$$\lim_{\lambda \rightarrow \infty} \sum_{n=0}^{\infty} \frac{(-\lambda)^n}{(2n+3)!} \eta(n) = 0$$

then it holds for all $\lambda > 0$ that

$$\mathbb{P} \left(\frac{Z}{\mathbb{E}(Z)} \leq \frac{1}{\lambda} \right) \leq \frac{\sum_{n=0}^{\infty} \frac{(-\lambda)^n}{(2n+3)!} \eta(n)}{1 - \sin(1)}$$

and in particular

$$\lim_{\lambda \rightarrow \infty} \mathbb{P} \left(\frac{Z}{\mathbb{E}(Z)} \leq \frac{1}{\lambda} \right) = 0.$$

Proof.

$$\mathbb{E} \left(g \left(\lambda \cdot \frac{Z}{\mathbb{E}(Z)} \right) \right) = \mathbb{E} \left(\sum_{n=0}^{\infty} \frac{(-\lambda)^n}{(2n+3)!} \left(\frac{Z}{\mathbb{E}(Z)} \right)^n \right) = \sum_{n=0}^{\infty} \frac{(-\lambda)^n}{(2n+3)!} \eta(n)$$

where the second equality holds by Dominated Convergence, because the RHS is bounded (for λ large enough).

Because g is strictly decreasing we have for all λ :

$$\mathbb{P} \left(\frac{Z}{\mathbb{E}(Z)} \leq \epsilon \right) = \mathbb{P} \left(g \left(\lambda \cdot \frac{Z}{\mathbb{E}(Z)} \right) \geq g(\lambda \cdot \epsilon) \right).$$

Since g is a positive function we can apply Markov's inequality to this equality, yielding:

$$\mathbb{P} \left(\frac{Z}{\mathbb{E}(Z)} \leq \epsilon \right) \leq \frac{\mathbb{E} \left(g \left(\lambda \cdot \frac{Z}{\mathbb{E}(Z)} \right) \right)}{g(\lambda \cdot \epsilon)}.$$

So for all $\lambda > 0$:

$$\mathbb{P} \left(\frac{Z}{\mathbb{E}(Z)} \leq \frac{1}{\lambda} \right) \leq \frac{\mathbb{E} \left(g \left(\lambda \cdot \frac{Z}{\mathbb{E}(Z)} \right) \right)}{g(1)} = \frac{\sum_{n=0}^{\infty} \frac{(-\lambda)^n}{(2n+3)!} \eta(n)}{1 - \sin(1)}$$

and by assumption the RHS converges to 0 as $\lambda \rightarrow \infty$.

\square

Lemma 3.5

Let Z_1, Z_2, \dots be a sequence of random variables with values in $\mathbb{R}_{\geq 0}$. Let $h(r), \eta(n), \delta(r)$ be real positive functions such that $\lim_{r \rightarrow \infty} h(r) = \infty$ and $\gamma(x) := \sum_{n=0}^{\infty} \frac{x^n}{(2n+3)!} \eta(n)$ converges for all $x \in \mathbb{R}$. If

$$1 - \delta(r) \leq \frac{\mathbb{E}(Z_r^n)}{\mathbb{E}(Z_r)^n} \cdot \frac{1}{\eta(n)} \leq 1 + \delta(r)$$

holds for all $r, n \in \mathbb{N}$, and:

$$\lim_{r \rightarrow \infty} \gamma(-h(r)) + \delta(r) \cdot \gamma(h(r)) = 0,$$

then:

$$\lim_{r \rightarrow \infty} \mathbb{P} \left(\frac{Z_r}{\mathbb{E}(Z_r)} \leq \frac{1}{h(r)} \right) = 0 \quad (3.10)$$

and if additionally there exist constants $c, \beta \geq 0$ such that $\mathbb{E}(Z_r) \geq c \cdot r^\beta$ for all r , then:

$$\lim_{r \rightarrow \infty} \mathbb{P} \left(\log_r(Z_r) \leq \beta - \frac{\log \left(\frac{h(r)}{c} \right)}{\log(r)} \right) = 0. \quad (3.11)$$

Proof.

$$\begin{aligned} \sum_{n=0}^{\infty} \frac{(-h(r))^n \mathbb{E}(Z_r^n)}{(2n+3)! \mathbb{E}(Z_r)^n} &= \sum_{n=0}^{\infty} \frac{(-h(r))^{2n} \mathbb{E}(Z_r^{2n})}{(4n+3)! \mathbb{E}(Z_r)^{2n}} - \frac{(-h(r))^{2n+1} \mathbb{E}(Z_r^{2n+1})}{(4n+5)! \mathbb{E}(Z_r)^{2n+1}} \\ &\leq \sum_{n=0}^{\infty} \frac{(-h(r))^{2n}}{(4n+3)!} \cdot \eta(2n)(1 + \delta(r)) - \frac{(-h(r))^{2n+1}}{(4n+5)!} \cdot \eta(2n+1)(1 - \delta(r)) \\ &= \sum_{n=0}^{\infty} \frac{(-h(r))^n}{(2n+3)!} \cdot \eta(n) + \delta(r) \cdot \sum_{n=0}^{\infty} \frac{(h(r))^n}{(2n+3)!} \cdot \eta(n) \\ &= \gamma(-h(r)) + \delta(r) \cdot \gamma(h(r)). \end{aligned}$$

Therefore Lemma 3.4 can be applied to conclude that:

$$\lim_{r \rightarrow \infty} \mathbb{P} \left(\frac{Z_r}{\mathbb{E}(Z_r)} \leq \frac{1}{h(r)} \right) \leq \lim_{r \rightarrow \infty} \frac{\sum_{n=0}^{\infty} \frac{(-h(r))^n \mathbb{E}(Z_r^n)}{(2n+3)! \mathbb{E}(Z_r)^n}}{1 - \sin(1)} \leq \lim_{r \rightarrow \infty} \gamma(-h(r)) + \delta(r) \cdot \gamma(h(r)) = 0. \quad (3.12)$$

As to the second part of the lemma:

$$\begin{aligned} \frac{Z_r}{\mathbb{E}(Z_r)} \leq \frac{1}{h(r)} &\Leftrightarrow \log_r(Z_r) \leq \log_r(\mathbb{E}(Z_r)) - \log_r(h(r)) \\ &\Leftrightarrow \log_r(Z_r) \leq \log_r(c \cdot r^\beta) - \log_r(h(r)) \\ &\Leftrightarrow \log_r(Z_r) \leq \beta - \log_r(h(r)) + \log_r(c) \end{aligned}$$

so

$$\lim_{r \rightarrow \infty} \mathbb{P} \left(\log_r(Z_r) \leq \beta - \frac{\log(h(r))}{\log(r)} + \frac{\log(c)}{\log(r)} \right) \leq \lim_{r \rightarrow \infty} \mathbb{P} \left(\frac{Z_r}{\mathbb{E}(Z_r)} \leq \frac{1}{h(r)} \right) = 0.$$

□

In case the ratios of moments $\frac{\mathbb{E}(Z_r^n)}{\mathbb{E}(Z_r)^n}$ don't depend on r , the result simplifies considerably.

Corollary 3.6

Let Z_1, Z_2, \dots be a sequence of random variables with values in $\mathbb{R}_{\geq 0}$. Let $h(r)$ be a positive real function such that $\lim_{r \rightarrow \infty} h(r) = \infty$ and suppose that $\eta(n) := \frac{\mathbb{E}(Z_r^n)}{\mathbb{E}(Z_r)^n}$ (independent of r !) satisfies:

$$\lim_{\lambda \rightarrow \infty} \sum_{n=0}^{\infty} \frac{(-\lambda)^n}{(2n+3)!} \eta(n) = 0.$$

Then

$$\lim_{r \rightarrow \infty} \mathbb{P} \left(\frac{Z_r}{\mathbb{E}(Z_r)} \leq \frac{1}{h(r)} \right) = 0 \quad (3.13)$$

and if additionally there exist constants $c, \beta \geq 0$ such that $\mathbb{E}(Z_r) \geq c \cdot r^\beta$ for all r , then:

$$\lim_{r \rightarrow \infty} \mathbb{P} \left(\log_r(Z_r) \leq \beta - \frac{\log(h(r))}{\log(r)} \right) = 0. \quad (3.14)$$

Proof. Apply Lemma 3.5 with zero error function $\delta(r) = 0$ to obtain (3.13). To obtain (3.14): apply Lemma 3.5 again, but now with $c \cdot h(r)$ instead of $h(r)$, in order to get rid of the annoying factor c that was necessary in (3.11). \square

As a side step: it is interesting to consider $E_0 := \left\{ \eta : \mathbb{N} \rightarrow \mathbb{R}_{>0} \text{ s.t. } \lim_{\lambda \rightarrow \infty} \sum_{n=0}^{\infty} \frac{(-\lambda)^n}{(2n+3)!} \eta(n) = 0 \right\}$, which is the set of functions that satisfy the assumption of the previous corollary. First note that E_0 forms a vector space. Besides linear transformations, are there other transformations under which E_0 is invariant? Yes: for all constants $c \in \mathbb{R}$ we have the equivalence:

$$(\eta(n)) \in E_0 \Leftrightarrow (\eta(n) \cdot c^n) \in E_0.$$

Furthermore, it can be verified that E_0 contains many natural functions, for example:

$$\left(\frac{(2n)!}{2^n \cdot n!} \right), (1), (n!), \left(\frac{1}{n+1} \right), \left(\frac{1}{n+2} \right) \in E_0.$$

In the next corollary we no longer consider general random variables Z_r . The focus is shifted to the IIC. The results on the IIC in this section are conditional; its assumptions are believed to hold true, but may be incorrect.

Corollary 3.7

Assume there exist positive real functions $\delta(r)$ and $h(r)$, such that $\lim_{r \rightarrow \infty} h(r) = \infty$ and

$$1 - \delta(r) \leq \frac{\mathbb{E}_{IIC}(|X_r|^n)}{\mathbb{E}_{IIC}(|X_r|)^n} \cdot \frac{2^n \cdot n!}{(2n)!} \leq 1 + \delta(r)$$

holds for all $r, n \in \mathbb{N}$ and

$$\lim_{r \rightarrow \infty} \delta(r) \cdot \frac{e^{h(r)/2}}{h(r)^3} = 0. \quad (3.15)$$

Then

$$\lim_{r \rightarrow \infty} \mathbb{P}_{IIC} \left(\frac{|X_r|}{\mathbb{E}_{IIC}(|X_r|)} \leq \frac{1}{h(r)} \right) = 0$$

and in particular:

$$\lim_{r \rightarrow \infty} \mathbb{P}_{IIC} \left(\log_r(|X_r|) \leq 4 - \frac{\log(\frac{h(r)}{c})}{\log(r)} \right) = 0,$$

where c is a constant such that $c \cdot r^4 \leq \mathbb{E}_{IIC}(|X_r|)$ holds for all r .

Proof. Our goal is to apply Lemma 3.5 with the choices $Z_r = |X_r|, \beta = 4$ and $\eta(n) = \frac{(2n)!}{2^n \cdot n!}$. By definition:

$$\gamma(x) := \sum_{n=0}^{\infty} \frac{(x)^n}{(2n+3)!} \cdot \frac{(2n)!}{2^n \cdot n!} = \sum_{n=0}^{\infty} (x/2)^n \cdot \frac{(2n)!}{(2n+3)! \cdot n!},$$

so

$$\begin{aligned}
\lim_{r \rightarrow \infty} \gamma(-h(r)) &= \lim_{r \rightarrow \infty} \sum_{n=0}^{\infty} (-r)^n \cdot \frac{(2n)!}{(2n+3)! \cdot n!} \\
&= \lim_{r \rightarrow \infty} \left[\frac{\sqrt{\pi}}{4} \cdot \frac{\operatorname{erf}(\sqrt{r})}{\sqrt{r}} \cdot \left(1 + \frac{1}{2r}\right) + \frac{e^{-r} - 2}{4r} \right] \\
&= 0.
\end{aligned} \tag{3.16}$$

Here $\operatorname{erf}(x) := \frac{2}{\sqrt{\pi}} \int_0^x e^{-t^2} dt$ is the error function encountered in integrating the normal distribution.

We now derive an asymptotic result on $\gamma(x)$, in order to simplify our analysis. It holds that

$$\gamma(x) = \sum_{n=0}^{\infty} \frac{(x/2)^n}{n!} \cdot \frac{1}{(2n+3)(2n+2)(2n+1)},$$

while

$$\begin{aligned}
\frac{e^{x/2}}{x^3} &= \sum_{n=0}^{\infty} \frac{(x/2)^n}{n!} \cdot \frac{1}{x^3} \\
&= \left(\frac{1}{x^3} + \frac{1}{2x^2} + \frac{1}{8x} \right) + \frac{1}{8} \sum_{n=0}^{\infty} \frac{(x/2)^{n+3}}{(n+3)!} \cdot \left(\frac{2}{x} \right)^3 \\
&= \left(\frac{1}{x^3} + \frac{1}{2x^2} + \frac{1}{8x} \right) + \sum_{n=0}^{\infty} \frac{(x/2)^n}{n!} \cdot \frac{1}{(2n+6)(2n+4)(2n+2)}.
\end{aligned}$$

Therefore:

$$\lim_{x \rightarrow \infty} \frac{\gamma(x)}{\left(\frac{e^{x/2}}{x^3} \right)} = 1. \tag{3.17}$$

For completeness we also give the converse statement, for $x \rightarrow -\infty$, which can be derived with similar standard series manipulations; we state it here without proof:

$$\lim_{x \rightarrow \infty} \frac{\gamma(-x)}{\left(\frac{\sqrt{\pi}}{2\sqrt{x}} \right)} = 1. \tag{3.18}$$

From (3.16), (3.17) and assumption (3.15) it follows that

$$\lim_{r \rightarrow \infty} \gamma(-h(r)) + \delta(r) \cdot \gamma(h(r)) < 0 + \lim_{r \rightarrow \infty} \delta(r) \cdot \left(\frac{e^{h(r)/2}}{h(r)^3} \right) = 0.$$

Therefore we are allowed to apply Lemma 3.5, which immediately yields the desired result. \square

One of the many possible choices for the functions $\delta(r)$ and $h(r)$ leads to the following corollary.

Corollary 3.8

Assume:

$$1 - \frac{\ln(r)^2}{r^{1/2}} \leq \frac{\mathbb{E}_{IIC}(|X_r|^n)}{\mathbb{E}_{IIC}(|X_r|)^n} \cdot \frac{2^n \cdot n!}{(2n)!} \leq 1 + \frac{\ln(r)^2}{r^{1/2}}$$

holds for all $r, n \in \mathbb{N}$. Then

$$\lim_{r \rightarrow \infty} \mathbb{P}_{IIC} \left(\frac{|X_r|}{\mathbb{E}_{IIC}(|X_r|)} \leq \frac{1}{\ln(r)} \right) = 0$$

and:

$$\lim_{r \rightarrow \infty} \mathbb{P}_{IIC} \left(\log_r(|X_r|) \leq 4 - \frac{\log\left(\frac{\ln(r)}{c}\right)}{\log(r)} \right) = 0,$$

where c is a constant such that $c \cdot r^4 \leq \mathbb{E}_{IIC}(|X_r|)$ holds for all r .

Proof. Take $h(r) = \ln(r)$ and $\delta(r) = \frac{\ln(r)^2}{r^{1/2}}$ in Corollary 3.7. and verify condition (3.15). \square

In this subsection we thusfar only derived conditional results on convergence *in probability*. But our main goal is to prove (under some assumptions) that $\log_r(|X_r|)$ converges *almost surely* to 4. This comes at a price: the necessary assumptions on $\frac{\mathbb{E}_{IIIC}(|X_r|^n)}{\mathbb{E}_{IIIC}(|X_r|)^n}$ become much stronger. This is mainly due to relatively minor simplifications that are necessary to perform a general analysis; if the exact values of $\frac{\mathbb{E}_{IIIC}(|X_r|^n)}{\mathbb{E}_{IIIC}(|X_r|)^n}$ were known, it would probably be possible to derive almost sure convergence of $\log_r(|X_r|)$ to 4, even if not all assumptions are met in the conditional results that we derive below. First we present a result for general random variables Z_r .

Lemma 3.9

Let Z_1, Z_2, \dots be a sequence of random variables with values in $\mathbb{R}_{\geq 0}$ such that $Z_1 \leq Z_2 \leq \dots$ and such that $c \cdot r^\beta \leq \mathbb{E}(Z_r)$ holds for some constant c and all $r \in \mathbb{N}$. Suppose $\eta(n) : \mathbb{N} \rightarrow \mathbb{R}_{\geq 0}$ is a function such that $\gamma(x) := \sum_{n=0}^{\infty} \frac{x^n}{(2n+3)!} \eta(n)$ converges for all $x \in \mathbb{R}$. Let $\delta(r) : \mathbb{N} \rightarrow \mathbb{R}_{\geq 0}$ be a function. If

$$1 - \delta(r) \leq \frac{\mathbb{E}(Z_r^n)}{\mathbb{E}(Z_r)^n} \cdot \frac{1}{\eta(n)} \leq 1 + \delta(r)$$

holds for all $r, n \in \mathbb{N}$ and if for some $\sigma \in \mathbb{N}, \mu > 0$ it holds that:

$$\sum_{k=1}^{\infty} \gamma(-k^{1+\mu}) + \delta(\sigma^k) \cdot \gamma(k^{1+\mu}) < \infty \tag{3.19}$$

then

$$\mathbb{P}(\liminf_{r \rightarrow \infty} (\log_r(Z_r)) \geq \beta) = 1.$$

Proof. Let $\epsilon > 0$. As in (3.12) in Lemma 3.5 it can be derived, with the choice $h(r) := r^\epsilon$, that

$$\begin{aligned} \mathbb{P}(\log_r(Z_r) \leq \beta - \epsilon - \log_r(c)) &= \mathbb{P}\left(\frac{Z_r}{c \cdot r^\beta} \leq \frac{1}{r^\epsilon}\right) \\ &\leq \mathbb{P}\left(\frac{Z_r}{\mathbb{E}(Z_r)} \leq \frac{1}{r^\epsilon}\right) \\ &\leq \gamma(-r^\epsilon) + \delta(r) \cdot \gamma(r^\epsilon). \end{aligned}$$

We now choose subsequences $r_k := \sigma^k$ and $\epsilon_k := \frac{1+\mu}{k \cdot \log_k(\sigma)}$, indexed by $k \in \mathbb{N}$. It follows that $r_k^{\epsilon_k} = \sigma^{\frac{1+\mu}{\log_k(\sigma)}} = k^{1+\mu}$, so:

$$\sum_{k=1}^{\infty} \mathbb{P}(\log_{r_k}(Z_{r_k}) \leq \beta - \epsilon_k - \log_{r_k}(c)) \leq \sum_{k=1}^{\infty} \gamma(-k^{1+\mu}) + \delta(\sigma^k) \cdot \gamma(k^{1+\mu}) < \infty.$$

By Borel-Cantelli this implies that:

$$\mathbb{P}(\log_{r_k}(Z_{r_k}) \leq \beta - \epsilon_k - \log_{r_k}(c) \text{ for infinitely many } k) = 0.$$

Note that $\lim_{k \rightarrow \infty} (\epsilon_k + \log_{r_k}(c)) = 0$. Therefore:

$$\mathbb{P}\left(\liminf_{k \rightarrow \infty} (\log_{r_k}(Z_{r_k})) \geq \beta\right) = 1.$$

Finally we want to extend this result to general $r \in \mathbb{N}$. Here the assumption that $Z_1 \leq Z_2 \leq \dots$ becomes necessary. For a given r choose k such that $\sigma^k \leq r \leq \sigma^{k+1}$. Then

$$\log_r(Z_r) = \frac{\log(Z_r)}{\log(r)} \geq \frac{\log(Z_{\sigma^k})}{\log(\sigma^{k+1})} = \frac{\log(Z_{\sigma^k})}{\log(\sigma^k)} \cdot \frac{\log(\sigma^k)}{\log(\sigma^{k+1})} = \log_{\sigma^k}(Z_{\sigma^k}) \cdot \frac{k}{k+1}.$$

Taking the lim inf yields:

$$\liminf_{r \rightarrow \infty} (\log_r(Z_r)) \geq \liminf_{k \rightarrow \infty} \left(\log_{\sigma^k}(Z_{\sigma^k}) \cdot \frac{k}{k+1} \right) = \liminf_{k \rightarrow \infty} (\log_{\sigma^k}(Z_{\sigma^k}))$$

and in conclusion:

$$\mathbb{P} \left(\liminf_{r \rightarrow \infty} (\log_r(Z_r)) \geq \beta \right) \geq \mathbb{P} \left(\liminf_{k \rightarrow \infty} (\log_{\sigma^k}(Z_{\sigma^k})) \geq \beta \right) = 1.$$

□

Corollary 3.10

Suppose there exists a function $\delta(r) : \mathbb{N} \rightarrow \mathbb{R}_{\geq 0}$ such that

$$1 - \delta(r) \leq \frac{\mathbb{E}_{IIC}(|X_r|^n)}{\mathbb{E}_{IIC}(|X_r|)^n} \cdot \frac{2^n \cdot n!}{(2n)!} \leq 1 + \delta(r)$$

holds for all $r, n \in \mathbb{N}$ and

$$\sum_{k=1}^{\infty} \delta(\sigma^k) \cdot \frac{e^{(k^2+2\mu)/2}}{k^{6(1+\mu)}} < \infty$$

is true for some $\sigma \in \mathbb{N}, \mu > 0$. Then

$$\mathbb{P}_{IIC}(d_m(IIC) = 4) = 1.$$

Proof. Lemma 3.9 will be applied with $Z_r = |X_r|$ and $\eta(n) = \frac{(2n)!}{2^n \cdot n!}$. Note that just as in Corollary 3.7 we have $\gamma(x) := \sum_{n=0}^{\infty} (x/2)^n \cdot \frac{(2n)!}{(2n+3)! \cdot n!}$, so we can use the asymptotic results in (3.17) and (3.18) to bound $\gamma(-k^{2+2\mu}) + \delta(\sigma^k) \cdot \gamma(k^{2+2\mu})$ from above by:

$$2 \cdot \left(\sqrt{\frac{\pi}{4 \cdot k^{2+2\mu}}} + \delta(\sigma^k) \cdot \frac{e^{k^{2+2\mu}/2}}{(k^{2+2\mu})^3} \right) := C_1 \cdot k^{-(2+2\mu)/2} + C_2 \cdot \delta(\sigma^k) \cdot \frac{e^{k^{2+2\mu}/2}}{k^{3(2+2\mu)}}.$$

for all k large enough. This weird expression has been fine-tuned so as to make its summation finite; there exists a $K \in \mathbb{N}$ such that:

$$\begin{aligned} \sum_{k=K}^{\infty} \gamma(-k^{1+(1+2\mu)}) + \delta(\sigma^k) \cdot \gamma(k^{1+(1+2\mu)}) &\leq C_1 \cdot \sum_{k=K}^{\infty} \frac{1}{k^{1+\mu}} + C_2 \cdot \sum_{k=K}^{\infty} \delta(\sigma^k) \cdot \frac{e^{k^{2+2\mu}/2}}{k^{6(1+\mu)}} \\ &< \infty. \end{aligned}$$

Thus we have verified that condition (3.19) is satisfied, with $\mu^* := 1 + 2\mu > 0$. From Lemma 3.9 we may now conclude that:

$$\mathbb{P}_{IIC}(\liminf_{r \rightarrow \infty} (\log_r(|X_r|)) \geq 4) = 1.$$

In other words: the lower mass dimension of the IIC almost surely is ≥ 4 . Finally combine this with the analogous statement on the upper mass dimension (Corollary 1.11) to obtain the desired statement: $\mathbb{P}_{IIC}(d_m(IIC) = 4) = 1$.

□

4 Positive probability lemma

In this section we prove Theorem 1.14 and we investigate an ‘almost independence’ condition under which it would follow from Theorem 1.14 that $\mathbb{P}_{IIC}(\overline{d_m(IIC)} \geq 4) = 1$.

4.1 For all r it holds that $|X_r|$ is of order r^4 with probability bounded away from 0

Lemma 4.1

For all $k \in \mathbb{R}_{>1}, \lambda \in \mathbb{R}_{\geq 1}$:

$$\mathbb{P}_{IIC} \left(|X_r| \geq \frac{E_{IIC}(|X_r|)}{\lambda} \right) \geq \left(1 - \frac{1}{\lambda} \right)^{\frac{k}{k-1}} \cdot \left(\frac{E_{IIC}(|X_r|)^k}{E_{IIC}(|X_r|^k)} \right)^{\frac{1}{k-1}}.$$

Proof. Write $s := \frac{E_{IIC}(|X_r|)}{\lambda}$ and define $Z_{\geq s} := |X_r| \cdot \mathbb{1}_{|X_r| \geq s}$. From Hölder’s inequality (with $\frac{1}{p} + \frac{1}{q} = 1$) it follows that

$$E_{IIC}(Z_{\geq s}) \leq \mathbb{E}_{IIC}(Z_{\geq s}^p)^{1/p} \cdot \mathbb{E}_{IIC}(\mathbb{1}_{|X_r| \geq s}^q)^{1/q}.$$

Therefore:

$$\mathbb{P}_{IIC}(|X_r| \geq s) \geq \frac{E_{IIC}(Z_{\geq s})^q}{E_{IIC}(Z_{\geq s}^p)^{q/p}} = \left(\frac{E_{IIC}(Z_{\geq s})^p}{E_{IIC}(Z_{\geq s}^p)} \right)^{\frac{1}{p-1}}. \quad (4.1)$$

By the definition of $Z_{\geq s}$ we have

$$E_{IIC}(Z_{\geq s}^p) \leq E_{IIC}(|X_r|^p)$$

and for all $\lambda > 0$:

$$\frac{E_{IIC}(Z_{\geq s})}{E_{IIC}(|X_r|)} = 1 - \frac{E_{IIC}(|X_r| \cdot \mathbb{1}_{|X_r| < s})}{E_{IIC}(|X_r|)} \geq 1 - \frac{s}{E_{IIC}(|X_r|)} = 1 - \frac{1}{\lambda}.$$

Evaluating these two estimates in (4.1) (and writing $k := p > 1$) yields the lemma. \square

Proof of Theorem 1.14

Proof. Evaluate Lemma 2.16 in Lemma 4.1 for the case $k = 2$. \square

Unfortunately we cannot conclude from the previous theorem that the mass dimension of the IIC equals 4 with positive probability, as we explained at the end of subsection 1.9.

4.2 Adapted Borel 0-1 law for almost independent events

Fix a $\lambda > 1$ and define the events $A_r := \left\{ |X_r| \geq \frac{E_{IIC}(|X_r|)}{\lambda} \right\}$. By Theorem 1.14 there exists a $C > 0$ such that $\mathbb{P}_{IIC}(A_r) \geq C$ holds for all r . Therefore one would expect that

$$\mathbb{P}_{IIC}(\overline{d_m(IIC)} \geq 4) = \mathbb{P}_{IIC} \left(\limsup_{r \rightarrow \infty} A_r \right) := \mathbb{P}_{IIC}(A_r \text{ for infinitely many } r) = 1, \quad (4.2)$$

because intuitively it seems inevitable that there exists an increasing subsequence (r_k) in \mathbb{N} such that the events A_{r_1}, A_{r_2}, \dots are ‘independent enough’, although we were not able to prove such an independence result yet. In the following we derive a theorem and corollary that make clear what kind of ‘independent enough’ would be sufficient to affirm claim (4.2).

Theorem 4.2 (Adapted ‘approximate independence’ Borel 0-1 law)

Let $(\Omega, \mathcal{A}, \mathbb{P})$ be a probability space. Let $(A_i)_{i \geq 1}$ be a sequence of events in \mathcal{A} . Suppose there exists a $C > 0$ such that $\mathbb{P}(A_i) \geq C$ for all i sufficiently large. Suppose furthermore that there exists a $1 \leq \beta < \frac{1}{1-C}$ such that for all i :

$$\frac{\mathbb{P}\left(\bigcap_{k=i}^{i+l} \overline{A_k}\right)}{\prod_{k=i}^{i+l} \mathbb{P}(\overline{A_k})} < \beta^l$$

holds for all l sufficiently large, then

$$\mathbb{P}\left(\limsup_i A_i\right) = 1.$$

Proof. We want to show that $\mathbb{P}(\limsup_i A_i) = 1$, or, equivalently, that

$$\mathbb{P}\left(\overline{\limsup_i A_i}\right) = 0.$$

Note that

$$\overline{\limsup_i A_i} = \overline{\bigcap_{i \geq 0} \bigcup_{j \geq i} A_j} = \bigcup_{i \geq 0} \bigcap_{j \geq i} \overline{A_j} = \bigcup_{i \geq 0} B_i.$$

where

$$B_i := \bigcap_{j \geq i} \overline{A_j} = \overline{A_i} \cap B_{i+1}$$

is an increasing sequence of events. As a consequence

$$\mathbb{P}\left(\overline{\limsup_i A_i}\right) = \lim_{i \rightarrow \infty} \mathbb{P}(B_i).$$

It therefore suffices to show that for all fixed i : $\mathbb{P}(B_i) = 0$. We will do so using the events

$$B_{i,l} := \bigcap_{i \leq k \leq i+l} \overline{A_k} = \overline{A_{i+l}} \cap B_{i,l-1}$$

that satisfy the following bound. For all l sufficiently large;

$$\begin{aligned} \mathbb{P}(B_{i,l}) &= \prod_{k=i}^{i+l} \mathbb{P}(\overline{A_k}) \cdot \frac{\mathbb{P}\left(\bigcap_{i \leq k \leq i+l} \overline{A_k}\right)}{\prod_{k=i}^{i+l} \mathbb{P}(\overline{A_k})} \\ &\leq \prod_{k=i}^{i+l} (1 - \mathbb{P}(A_k)) \cdot \frac{\mathbb{P}\left(\bigcap_{i \leq k \leq i+l} \overline{A_k}\right)}{\prod_{k=i}^{i+l} \mathbb{P}(\overline{A_k})} \\ &\leq (1 - C)^l \cdot \beta^l \end{aligned}$$

Because $B_{i,l}$ is decreasing in l we conclude that

$$\mathbb{P}(B_i) = \lim_{l \rightarrow \infty} \mathbb{P}(B_{i,l}) \leq \lim_{l \rightarrow \infty} ((1 - C)\beta)^l = 0.$$

□

Corollary 4.3

Fix a $\lambda > 1$. Let $C > 0$ be such that $\mathbb{P}_{IIC}(|X_r| \geq \frac{\mathbb{E}_{IIC}(|X_r|)}{\lambda}) \geq C$ holds for all r (such a C exists by Theorem 1.14). Suppose there exist a constant β satisfying $1 \leq \beta \leq \frac{1}{1-C}$ and a strictly increasing sequence (r_k) in \mathbb{N} such that for all i :

$$\frac{\mathbb{P}_{IIC}\left(\bigcap_{i \leq k \leq i+l} \left(|X_{r_k}| < \frac{\mathbb{E}_{IIC}(|X_{r_k}|)}{\lambda}\right)\right)}{\prod_{k=i}^{i+l} \mathbb{P}_{IIC}\left(|X_{r_k}| < \frac{\mathbb{E}_{IIC}(|X_{r_k}|)}{\lambda}\right)} < \beta^l$$

holds for all l sufficiently large, then

$$\mathbb{P}_{IIC}(\overline{d_m(IIC)} = 4) = 1.$$

Proof. Because $\left\{|X_{r_k}| < \frac{E_{IIC}(|X_{r_k}|)}{\lambda}\right\}$ is the complement of the event $A_k := \left\{|X_{r_k}| \geq \frac{E_{IIC}(|X_{r_k}|)}{\lambda}\right\}$ we may apply Theorem 4.2 to conclude that $\mathbb{P}_{IIC}(\limsup_i A_i) = 1$. From Theorem 1.9 we know there is a $c > 0$ such that $\mathbb{E}_{IIC}(|X_r|) \geq c \cdot r^4$ for all r , so

$$\begin{aligned}
\mathbb{P}_{IIC}(\overline{d_m}(IIC) \geq 4) &= \mathbb{P}_{IIC}\left(\limsup_r (\log_r |X_r|) \geq 4\right) \\
&\geq \mathbb{P}_{IIC}\left(\limsup_i (\log_{r_i} |X_{r_i}|) \geq 4\right) \\
&\geq \mathbb{P}_{IIC}\left(\log_{r_i} |X_{r_i}| \geq 4 + \log_{r_i}\left(\frac{c}{\lambda}\right) \text{ for infinitely many } i\right) \\
&= \mathbb{P}_{IIC}(A_i \text{ for infinitely many } i) \\
&= \mathbb{P}_{IIC}\left(\limsup_i A_i\right) \\
&= 1.
\end{aligned}$$

This, together with the upper bound in (1.16), finishes the proof. □

5 Discrete Hausdorff dimension

5.1 Definition Hausdorff dimensions

In the year 1919 Hausdorff introduced the notion of what later became known as Hausdorff dimension [24]. It was a generalization of an idea which had already been introduced in 1914 by Carathéodory, but Hausdorff realised that Carathéodory's construction made sense and was useful, in particular for defining fractional dimensions [25]. Almost 100 years later, we are living in an age where applications in science take place on smaller and smaller scales. Materials can be manipulated on an atomic level, yielding unexpected properties on a large scale. The study of discrete systems, rather than continuous systems, gains importance. In this light, though only remotely related, it is of interest to investigate in what ways the concept of Hausdorff dimension can be defined in a discrete context.

In 1989 Barlow and Taylor [26] defined such a discrete version of Hausdorff dimension for sets in \mathbb{Z}^d . Among other things they show that some simple sets (like k -dimensional hyperplanes) have the expected discrete Hausdorff dimension (k). They calculate the Hausdorff dimension of a set A by using the mass dimension of A as upper bound and a discrete version of the so called *mass method* to find the (same) lower bound. In short, the mass method depends on choosing an optimal covering of A by cubes, along with an assumption on *all* cubes, say Assumption X. Unfortunately, in our probabilistic setting this seems useless; we can show that Assumption X holds with probability converging to 1 when we choose a cube uniformly at random, but what we actually need is that Assumption X holds with probability converging to 1 for a cube chosen uniformly among the cubes in the optimal covering. We cannot control this optimal covering.

In this section we present an alternative discrete Hausdorff dimension on \mathbb{Z}^d . Compared to the definition of Barlow and Taylor it is slightly more flexible. In construction and notation it highly resembles the usual 'continuous' Hausdorff dimension, but it is fundamentally different in that the discrete Hausdorff dimension of a (countable!) subset of \mathbb{Z}^d may be nonzero. A particular advantage of the notational similarities, is that it's relatively intuitive to generalize the *energy method* [14] for continuous Hausdorff dimension to an energy method for discrete Hausdorff dimension (see Lemma 5.6 and Theorem 5.7 below). Just as the mass method, the energy method provides a lower bound on the Hausdorff dimension, but in a probabilistic setting it is much more powerful because it suffices to calculate a certain expectation value. For example, in the continuous case this method is employed to show that Brownian motion almost surely has Hausdorff dimension 2 [14].

Since this is primarily a thesis on a percolation subject and not on Hausdorff dimension, we will not elaborate on general properties, differences between various definitions, consistency issues, Hausdorff measures, etcetera. Our main goal is to calculate the discrete Hausdorff dimension of a certain random subset, the IIC, of which the discrete dimension will be shown to be equal to 4 a.s. under the assumption on the value of $\mathbb{E}_{IIC}(|X_r|^{-4})$ stated in Corollary (5.13). Unfortunately, due to the fact that even calculating expectation values is hard when dealing with the IIC, this big assumption remains necessary.

The majority of this section involves results that hold for a rather general probability space with probability measure \mathbb{P} . Only at the end, where the Hausdorff dimension of the IIC is calculated, it is necessary to use \mathbb{P}_{IIC} .

Before introducing the discrete Hausdorff dimension we recall the definition of the usual continuous Hausdorff dimension, for comparison. Let (X, m) be a metric space. For any subset $U \subset X$, let $\text{diam}(U) := \sup_{x, y \in U} \{m(x, y)\}$ denote its diameter. For a subset $A \subset X$ and any real $\alpha, \epsilon > 0$, define

$$\mathcal{H}_\epsilon^\alpha(A) := \inf \left\{ \sum_{i=1}^{\infty} \text{diam}(U_i)^\alpha \mid A \subset \bigcup_{i=1}^{\infty} U_i \text{ such that } \text{diam}(U_i) \leq \epsilon \right\}$$

where the infimum is over all countable covers of A by open sets $U_i \subset X$. The **Hausdorff dimension**

of A is then defined by

$$d_{\mathcal{H}}(A) = \sup \left\{ \alpha \mid \limsup_{\epsilon \downarrow 0} \mathcal{H}_{\epsilon}^{\alpha}(A) = \infty \right\}.$$

In the discrete context, the role of the covering sets U_i will be taken by the following cubes.

Definition 5.1

For a vertex $x = (x_1, \dots, x_d) \in \mathbb{Z}^d$ and $n \geq 1$ we set

$$T(x, n) = \{y \in \mathbb{Z}^d \mid x_i \leq y_i < x_i + n\}. \quad (5.1)$$

We call $T(x, n)$ the cube with base x and diameter n . If T is a cube we denote by $s(T)$ the diameter of the cube, with respect to the metric induced by the supremum norm.

For comparison:

Definition 5.2

The **Barlow and Taylor discrete Hausdorff dimension** of a subset $A \subset \mathbb{Z}^d$ is defined as

$$d_H(A) := \sup \{ \alpha \mid m_{\alpha}(A) = \infty \}$$

where

$$m_{\alpha}(A) = \sum_{n=1}^{\infty} \min \left(\sum_{i=1}^m \left(\frac{s(T_j)}{2^n} \right)^{\alpha} \mid A \cap S_n \subset \bigcup_{j=1}^m T_j \right)$$

and $S_n := Q_{2^{n-1}} \setminus Q_{2^{n-2}}$. The minimum is taken over all covers of $A \cap S_n$ by any set of cubes T_j that are of the form (5.1).

Now we finally introduce the discrete Hausdorff dimension that we *will* use in this section.

Definition 5.3

Let $\epsilon: \mathbb{N}_{\geq 1} \rightarrow \mathbb{R}_{>0}$ be a function such that $\lim_{r \rightarrow \infty} \epsilon(r) = 0$ and $\epsilon(r) \geq \frac{1}{r}$ for all r . The **discrete Hausdorff dimension with respect to $\epsilon(r)$** of a subset $A \subset \mathbb{Z}^d$ is defined as

$$d_{\mathcal{H}, \epsilon(r)}(A) := \sup \left\{ \alpha \mid \limsup_{r \rightarrow \infty} \mathcal{H}_{\epsilon(r)}^{\alpha}(A) = \infty \right\},$$

where

$$\mathcal{H}_{\epsilon(r)}^{\alpha}(A) := \min \left(\sum_j \left(\frac{s(T_j)}{r} \right)^{\alpha} \mid A \cap Q_r \subset \bigcup_j T_j \text{ such that } \frac{s(T_j)}{r} \leq \epsilon(r) \right).$$

Here the minimum is taken over all covers of $A \cap Q_r$ by any set of pairwise disjoint cubes T_j that are of the form (5.1).

Note that in the definition of $\mathcal{H}_{\epsilon(r)}^{\alpha}$ it suffices to take the minimum, rather than the infimum. Indeed: $A \cap Q_r$ can be covered by a finite set of cubes B_1, \dots, B_m for which $\Sigma := \sum_j \left(\frac{s(B_j)}{r} \right)^{\alpha}$. There are only finitely many cubes T_i such that $\frac{s(T_i)}{r} \leq \Sigma$, so there are also finitely many covers of $A \cap Q_r$ by cubes T_1, T_2, \dots such that $\sum_j \left(\frac{s(T_j)}{r} \right)^{\alpha} \leq \Sigma$.

In the remainder of this section: whenever a function is denoted by $\epsilon(r)$, it is assumed that it satisfies the requirements stated in Definition 5.3.

Lemma 5.4

(The discrete Hausdorff dimension is smaller than or equal to the upper mass dimension)

Let $A \subset \mathbb{Z}^d$. Then for all $\epsilon(r)$:

$$d_{\mathcal{H}, \epsilon(r)}(A) \leq \overline{d}_m(A).$$

Proof. Let $\alpha > \beta > \overline{d}_m(A)$. Recall the definition of upper mass dimension to see that $|A \cap Q_r| \leq r^\beta$ for all r large enough. Now cover $A \cap Q_r$ by $|A \cap Q_r|$ cubes T_j with diameter $s(T_j) = 1$. These cubes all satisfy the requirement $\frac{s(T_j)}{r} = \frac{1}{r} \leq \epsilon(r)$ in Definition 5.3. It follows that $\mathcal{H}_{\epsilon(r)}^\alpha \leq \sum_j \left(\frac{s(T_j)}{r}\right)^\alpha = \frac{|A \cap Q_r|}{r^\alpha} \leq \frac{r^\beta}{r^\alpha}$ for all r large enough. So $\limsup_{r \rightarrow \infty} \mathcal{H}_{\epsilon(r)}^\alpha \leq \limsup_{r \rightarrow \infty} r^{\beta-\alpha} = 0$. So $d_{\mathcal{H}, \epsilon(r)}(A) \leq \alpha$. Now take the limit $\alpha \downarrow \overline{d}_m(A)$. \square

So by Corollary 1.11 we know in particular that the discrete Hausdorff dimension of the IIC is almost surely ≤ 4 .

5.2 Discrete energy method

In this subsection we derive a discrete variant of the energy method, which in the next subsection will provide a lower bound on $d_{\mathcal{H}, \epsilon(r)}(A)$.

Definition 5.5

A **mass distribution** μ on a metric space E is a measure on E such that $0 < \mu(E) < \infty$.

Lemma 5.6

(Energy method for discrete Hausdorff dimension)

Let $\alpha \geq 0$, let $A \subset \mathbb{Z}^d$ and let μ be a mass distribution on the metric space $(A \cap Q_r, m)$, where m denotes the metric induced by the supremum norm. Then for all $r \in \mathbb{N}_{\geq 1}$.

$$\mathcal{H}_{\epsilon(r)}^\alpha(A) \geq \frac{\mu(A \cap Q_r)^2}{r^\alpha \cdot \iint_{\frac{m(x,y)}{r} < \epsilon(r)} \frac{d\mu(x)d\mu(y)}{\max(m(x,y), 1)^\alpha}}.$$

Proof. Suppose T_1, T_2, \dots is a pairwise disjoint covering of $A \cap Q_r$ by cubes of diameter $< \epsilon(r)r$, such that $\sum_j s_m(T_j)^\alpha$ is minimal. Then

$$\iint_{\frac{m(x,y)}{r} < \epsilon(r)} \frac{r^\alpha d\mu(x)d\mu(y)}{\max(m(x,y), 1)^\alpha} \geq \sum_j \iint_{T_j \times T_j} \frac{d\mu(x)d\mu(y)}{\max(\frac{m(x,y)}{r}, \frac{1}{r})^\alpha} \geq \sum_j \frac{\mu(T_j)^2}{\left(\frac{s(T_j)}{r}\right)^\alpha}$$

Now we bound $\mu(A \cap Q_r)$:

$$\mu(A \cap Q_r) \leq \sum_j \mu(T_j) = \sum_j \left(\frac{s(T_j)}{r}\right)^{\alpha/2} \frac{\mu(T_j)}{\left(\frac{s(T_j)}{r}\right)^{\alpha/2}}.$$

Applying Cauchy-Schwarz and then using that $\sum_j \left(\frac{s(T_j)}{r}\right)^\alpha$ is minimal, yields:

$$\mu(A \cap Q_r)^2 \leq \sum_j \left(\frac{s(T_j)}{r}\right)^\alpha \cdot \sum_j \frac{\mu(T_j)^2}{\left(\frac{s(T_j)}{r}\right)^\alpha} \leq \mathcal{H}_{\epsilon(r)}^\alpha(A) \cdot r^\alpha \iint_{\frac{m(x,y)}{r} < \epsilon(r)} \frac{d\mu(x)d\mu(y)}{\max(m(x,y), 1)^\alpha}.$$

\square

A notable difference with the original energy method, for the usual ‘continuous’ Hausdorff dimension, is that we used the factor $\max(m(x,y), 1)$ rather than $m(x,y)$. We do this to prevent division by zero which would otherwise occur in the denominator of the right hand side for natural measures on \mathbb{Z}^d like the counting measure. This would render the statement trivial and useless.

Usually the energy method is formulated for general metrics m . Since we will only use the ‘Manhattan’ metric induced by the supremum norm and to prevent unnecessary complicated notation we have refrained from describing the discrete energy method in such generality.

The next step is to apply Lemma 5.6 with the counting measure. Let μ_* denote the counting measure on \mathbb{Z}^d . Also, from now on we write $m(x, y) = |x - y|$ for all $x, y \in \mathbb{Z}^d$. It follows that:

$$\mathcal{H}_{\epsilon(r)}^\alpha(A) \geq \frac{\mu_*(A \cap Q_r)^2}{r^\alpha \iint_{\frac{m(x,y)}{r} < \epsilon(r)} \frac{d\mu_*(x)d\mu_*(y)}{\max(m(x,y), 1)^\alpha}} = \frac{|A \cap Q_r|^2}{\sum_{\substack{x,y \in A \cap Q_r \\ |x-y| < \epsilon(r) \cdot r}} \left(\frac{r}{\max(|x-y|, 1)} \right)^\alpha}. \quad (5.2)$$

5.3 Almost sure lower bounds for the discrete Hausdorff dimension of a random set $A \subset \mathbb{Z}^d$

In the following Lemmas we derive results for random sets. In the context of the IIC, relevant examples of random sets are the cluster of the origin $A = IIC$ and its backbone $A = Bb^*$.

Theorem 5.7

Let $A \subset \mathbb{Z}^d$ be a random set. If for all $\alpha < \beta$:

$$\lim_{r \rightarrow \infty} \mathbb{E} \left(\frac{\sum_{\substack{x,y \in A \cap Q_r \\ 1 \leq |x-y| < \epsilon(r) \cdot r}} \left(\frac{r}{|x-y|} \right)^\alpha}{|A \cap Q_r|^2} \right) = 0$$

then

$$\mathbb{P}(d_{\mathcal{H}, \epsilon(r)}(A) \geq \beta) = 1.$$

Proof. Let $\alpha < \beta$. Equation (5.2) implies that

$$\lim_{r \rightarrow \infty} \mathbb{E} \left(\left(\mathcal{H}_{\epsilon(r)}^\alpha(A) \right)^{-1} \right) = 0.$$

This implies by Fatou's Lemma that

$$\mathbb{E} \left(\liminf_r \left(\mathcal{H}_{\epsilon(r)}^\alpha(A) \right)^{-1} \right) = 0$$

so

$$\mathbb{P} \left(\limsup_r \mathcal{H}_{\epsilon(r)}^\alpha(A) = \infty \right) = \mathbb{P} \left(\liminf_r \left(\mathcal{H}_{\epsilon(r)}^\alpha(A) \right)^{-1} = 0 \right) = 1$$

so

$$\mathbb{P}(d_{\mathcal{H}, \epsilon(r)}(A) \geq \alpha) = 1.$$

□

The statement of the previous lemma can be made a little more symmetric by writing $|A \cap Q_r|^2 = \sum_{x,y \in A \cap Q_r} (1)$. We can dissect the statement even more by defining

$$\mathbb{B}_A(r, k) := \mathbb{E} \left(\frac{\sum_{\substack{x,y \in A \cap Q_r \\ |x-y|=k}} (1)}{\sum_{x,y \in A \cap Q_r} (1)} \right),$$

because

$$\mathbb{E} \left(\frac{\sum_{\substack{x,y \in A \cap Q_r \\ 1 \leq |x-y| < \epsilon(r) \cdot r}} \left(\frac{r}{|x-y|} \right)^\alpha}{\sum_{x,y \in A \cap Q_r} (1)} \right) = \sum_{k=1}^{\lfloor \epsilon(r)r \rfloor} \mathbb{B}(k) \cdot \left(\frac{r}{k} \right)^\alpha. \quad (5.3)$$

Lemma 5.8

Let $A \subset \mathbb{Z}^d$ be a random set. Let $\delta(r) : \mathbb{N}_{>0} \rightarrow \mathbb{R}_{\geq 0}$ be any function and let $\beta \in \mathbb{R}$. If there is a constant C such that for all k, r it holds that $\mathbb{B}_A(r, k) \leq C \cdot \frac{k^{\beta-1}}{r^\beta} \cdot \delta(r)$, then

$$\mathbb{P} \left(d_{\mathcal{H}, \epsilon(r)}(A) \geq \sup_{\alpha} \left\{ \lim_{r \rightarrow \infty} \delta(r) \cdot \epsilon(r)^{\beta-\alpha} = 0 \right\} \right) = 1.$$

Proof. Let $\alpha < \sup_{\alpha} \left\{ \lim_{r \rightarrow \infty} \delta(r) \cdot \epsilon(r)^{\beta-\alpha} = 0 \right\}$. Then:

$$\begin{aligned} \lim_{r \rightarrow \infty} \sum_{k=1}^{\lfloor \epsilon r \rfloor} \mathbb{B}_A(r, k) \left(\frac{r}{k} \right)^{\alpha} &\leq C \cdot \lim_{r \rightarrow \infty} \frac{\delta(r)}{r^{\beta-\alpha}} \sum_{k=1}^{\lfloor \epsilon(r)r \rfloor} k^{\beta-\alpha-1} \\ &\leq C' \cdot \lim_{r \rightarrow \infty} \frac{\delta(r)}{r^{\beta-\alpha}} (\epsilon(r)r)^{\beta-\alpha} \\ &= 0. \end{aligned}$$

In the second inequality we used that for all $\gamma > -1$ one has $\sum_{k=1}^r k^\gamma = \mathcal{O}(r^{\gamma+1})$. Indeed: $\sum_{k=2}^r k^\gamma \leq \int_2^r (k-1)^\gamma dk = \mathcal{O}(r^{\gamma+1})$ if $\gamma < 0$, while $\sum_{k=2}^r k^\gamma \leq \int_2^r (k+1)^\gamma dk = \mathcal{O}(r^{\gamma+1})$ if $\gamma \geq 0$.

Now the lemma follows by equality (5.3) and Theorem 5.7. \square

Corollary 5.9

If (as we conjecture) there exists a constant C such that for all $k, r \in \mathbb{N}$ it holds that $\mathbb{B}_{IIC}(r, k) \leq C \cdot \frac{k^3}{r^4}$, then:

$$\mathbb{P}_{IIC}(d_{\mathcal{H}, \epsilon(r)}(IIC) \geq 4) = 1,$$

irrespective of the function $\epsilon(r)$.

Proof. Apply Lemma 5.8 to the infinite cluster (IIC), with $\delta(r) = 1$ and $\beta = 4$. \square

Lemma 5.8 is already a useful simplification but typically it is still hard to bound $\mathbb{B}_A(r, k)$ for random sets like the IIC. As will become clear later in Theorem 5.12, it is relatively easy to bound the sum

$$\mathbb{E}_{IIC} \left(\frac{\sum_{\substack{x, y \in A \cap Q_r(1) \\ 1 \leq |x-y| \leq K}}}{\sum_{x, y \in A \cap Q_r(1)}} \right) = \sum_{k=1}^K \mathbb{B}_A(r, k).$$

In order to make such a bound useful for our purposes we will need a variant of Lemma 5.8, namely the upcoming Theorem 5.11. First a technical lemma.

Lemma 5.10

Let $f(k) : \mathbb{N}_{>0} \rightarrow \mathbb{R}_{\geq 0}$ be a decreasing function. Let $g(k) : \mathbb{N}_{>0} \rightarrow \mathbb{R}_{\geq 0}$ be any function. Suppose there exist $\beta > 0, C > 0$ such that for all K : $\sum_{k=1}^K g(k) \leq C \cdot K^\beta$. Then for all K :

$$\sum_{k=1}^K g(k) f(k) \leq C \cdot \sum_{k=1}^K (k^\beta - (k-1)^\beta) \cdot f(k).$$

Proof. Consider functions of the form $h(k) : \mathbb{N}_{>0} \rightarrow \mathbb{R}_{\geq 0}$, with the constraint that for all $K > 0$: $\sum_{k=1}^K h(k) \leq C \cdot K^\beta$. Because $f(k)$ is decreasing, $\sum_{k=1}^K h(k) f(k)$ is maximized by subsequently maximizing $\sum_{k=1}^1 h(k), \sum_{k=1}^2 h(k), \dots, \sum_{k=1}^K h(k)$, with maxima $C \cdot 1^\beta, C \cdot 2^\beta, \dots, C \cdot K^\beta$. As a consequence $h(k) = \sum_{x=1}^k h(x) - \sum_{x=1}^{k-1} h(x) = C \cdot (k^\beta - (k-1)^\beta)$ holds for all k if $\sum_{k=1}^K h(k) f(k)$ is maximal. \square

Theorem 5.11

Let $A \subset \mathbb{Z}^d$ be a random set. Let $\delta(r) : \mathbb{N}_{>0} \rightarrow \mathbb{R}_{\geq 0}$ be any function and let $\beta \in \mathbb{R}$. Suppose there exists a constant C such that for all $r, K \in \mathbb{N}$ it holds that $\sum_{k=1}^K \mathbb{B}_A(r, k) \leq C \cdot \frac{K^\beta}{r^\beta} \cdot \delta(r)$. Then:

$$\mathbb{P} \left(d_{\mathcal{H}, \epsilon(r)}(A) \geq \sup_{\alpha} \left\{ \lim_{r \rightarrow \infty} \delta(r) \cdot \epsilon(r)^{\beta-\alpha} = 0 \right\} \right) = 1.$$

Proof. Let $\alpha < \sup_{\alpha} \{ \lim_{r \rightarrow \infty} \delta(r) \cdot \epsilon(r)^{\beta - \alpha} = 0 \}$. Apply Lemma 5.10 with the decreasing function $f(k) := \left(\frac{r}{k}\right)^{\alpha}$ and the function $g(k) := \mathbb{B}_A(r, k)$. Since $\sum_{k=1}^K g(k) \leq \frac{C \cdot \delta(r)}{r^{\beta}} \cdot K^{\beta}$, it follows with the choice $K := \epsilon(r)r$ that:

$$\begin{aligned} \sum_{k=1}^{\lfloor \epsilon(r)r \rfloor} \mathbb{B}_A(r, k) \cdot \left(\frac{r}{k}\right)^{\alpha} &\leq \frac{C \cdot \delta(r)}{r^{\beta}} \cdot \sum_{k=1}^{\lfloor \epsilon(r)r \rfloor} (k^{\beta} - (k-1)^{\beta}) \cdot \left(\frac{r}{k}\right)^{\alpha} \\ &\leq C' \cdot \delta(r) \cdot r^{\alpha - \beta} \cdot \sum_{k=1}^{\lfloor \epsilon(r)r \rfloor} k^{\beta - \alpha - 1} \\ &\leq C'' \cdot \delta(r) \cdot r^{\alpha - \beta} \cdot (\epsilon(r)r)^{\beta - \alpha} \\ &= C'' \cdot \delta(r) \cdot \epsilon(r)^{\beta - \alpha}. \end{aligned}$$

for some constants C', C'' independent of r . In the third inequality we again, as in Lemma 5.8, used that for all $\gamma > -1$ one has $\sum_{k=1}^r k^{\gamma} = \mathcal{O}(r^{\gamma+1})$.

We conclude that

$$\begin{aligned} \lim_{r \rightarrow \infty} \mathbb{E} \left(\frac{\sum_{\substack{x, y \in A \cap Q_r \\ 1 \leq |x-y| < \epsilon(r)r}} \left(\frac{r}{|x-y|}\right)^{\alpha}}{\sum_{x, y \in A \cap Q_r} (1)} \right) &= \lim_{r \rightarrow \infty} \sum_{k=1}^{\lfloor \epsilon(r)r \rfloor} \mathbb{B}_A(r, k) \cdot \left(\frac{r}{k}\right)^{\alpha} \\ &\leq \lim_{r \rightarrow \infty} C'' \cdot \delta(r) \cdot \epsilon(r)^{\beta - \alpha} \\ &= 0. \end{aligned}$$

An application of Theorem reffirstderivationofenergymethod to this equality wraps up the proof. \square

5.4 Conditional proof of the discrete Hausdorff dimension of the IIC

Until now, this section treated results that are quite general and don't necessarily have something to do with our particular probability measure, or even percolation. In the next theorem we use the expectation value bound of Corollary 2.12, thereby introducing a result that holds specifically for percolation under the IIC-measure. We obtain almost sure statements on the value of the discrete Hausdorff dimension of the IIC, under an as yet unverifiable assumption on the value of $\mathbb{E}_{IIC} \left(\frac{1}{|X_r|^4} \right)$.

Theorem 5.12

Let $\delta(r) : \mathbb{N} \rightarrow \mathbb{R}_{\geq 1}$ be a function. Assume there is a constant C such that for all r :

$$\mathbb{E}_{IIC} \left(\frac{1}{|X_r|^4} \right) \leq C \cdot \frac{\delta^2(r)}{r^{16}}. \quad (5.4)$$

Then:

$$\mathbb{P}_{IIC} \left(d_{\mathcal{H}, \epsilon(r)}(IIC) \geq \sup_{\alpha} \left\{ \lim_{r \rightarrow \infty} \delta(r) \cdot \epsilon(r)^{4 - \alpha} = 0 \right\} \right) = 1.$$

Proof. The following derivation first uses Cauchy Schwarz and then assumption (5.4) and case $n = 2$ of Corollary 2.12.

$$\begin{aligned} \mathbb{E}_{IIC}^2 \left(\frac{\sum_{\substack{x, y \in IIC \cap Q_r \\ |x-y| \leq k}} (1)}{\sum_{x, y \in IIC \cap Q_r} (1)} \right) &:= \mathbb{E}_{IIC}^2 \left(\frac{1}{|X_r|^2} \cdot \sum_{\substack{x, y \in IIC \cap Q_r \\ |x-y| \leq k}} (1) \right) \\ &\leq \mathbb{E}_{IIC} \left(\frac{1}{|X_r|^4} \right) \cdot \mathbb{E}_{IIC} \left(\left(\sum_{\substack{x, y \in IIC \cap Q_r \\ |x-y| \leq k}} (1) \right)^2 \right) \\ &\leq C \cdot \frac{\delta(r)^2}{r^{16}} \cdot r^8 \cdot k^8. \end{aligned}$$

So

$$\sum_{k=1}^K \mathbb{B}_{IIC}(r, k) := \mathbb{E}_{IIC} \left(\frac{\sum_{\substack{x, y \in IIC \cap Q_r \\ |x-y| \leq K}} (1)}{\sum_{x, y \in IIC \cap Q_r} (1)} \right) \leq C \cdot \frac{K^4}{r^4} \delta(r).$$

Now apply Theorem 5.11 with $\beta = 4$. □

Corollary 5.13

Let $\delta \geq 0$. Assume there is a constant C such that for all r :

$$\mathbb{E}_{IIC} \left(\frac{1}{|X_r|^4} \right) \leq C \cdot \frac{\epsilon(r)^{-2\delta}}{r^{16}}. \quad (5.5)$$

Then:

$$\mathbb{P}_{IIC} (d_{\mathcal{H}, \epsilon(r)}(IIC) \geq 4 - \delta) = 1 \quad (5.6)$$

and in particular, if the assumption is true for all $\delta > 0$ (or for $\delta = 0$), then it \mathbb{P}_{IIC} -almost surely holds that:

$$d_{\mathcal{H}, \epsilon(r)}(IIC) = d_m(IIC) = 4.$$

Proof. Apply Theorem 5.12 with $\delta(r) = \epsilon(r)^{-\delta}$ and note that $\sup_{\alpha} \{ \lim_{r \rightarrow \infty} \epsilon(r)^{-\delta} \cdot \epsilon(r)^{4-\alpha} = 0 \} = 4 - \delta$ because by definition: $\lim_{r \rightarrow \infty} \epsilon(r) = 0$. This finishes the proof of (5.6).

Lemma 5.4 ("Hausdorff dimension \leq upper mass dimension") and Corollary 1.11 ("upper mass dimension ≤ 4 ") conclude the proof that \mathbb{P}_{IIC} -almost surely: $d_{\mathcal{H}, \epsilon(r)}(IIC) = \overline{d}_m(IIC) = 4$.

It remains to show that the lower mass dimension \mathbb{P}_{IIC} -almost surely equals 4. Note that by Markov's inequality and because (by definition) $\epsilon(r) \geq \frac{1}{r}$, it follows that for all $\epsilon > 0$:

$$\mathbb{P}_{IIC}(|X_r| \leq r^{4-\frac{\delta}{2}-\epsilon}) \leq \mathbb{P}_{IIC}(|X_r| \leq r^{4-\epsilon} \cdot \epsilon(r)^{\frac{\delta}{2}}) = \mathbb{P}_{IIC} \left(\frac{1}{|X_r|^4} \geq \frac{r^{4\epsilon-16}}{\epsilon(r)^{2\delta}} \right) \leq \frac{\mathbb{E}_{IIC}(\frac{1}{|X_r|^4})}{r^{4\epsilon-16} \epsilon(r)^{-2\delta}} \leq \frac{C}{r^{4\epsilon}},$$

so by Theorem 1.10 we have that $\mathbb{P}_{IIC} (\liminf_{r \rightarrow \infty} (\log_r(|X_r|)) \geq 4 - \frac{\delta}{2}) = 1$. Since this by assumption holds for all $\delta > 0$ (or for $\delta = 0$) it follows that \mathbb{P}_{IIC} -almost surely: $\underline{d}_m(IIC) = 4$. □

6 Lower bound on $|X_{r,r}|$

This subsection is about Theorem 1.16. To prove it we will bound the IIC-measure of the event $\{|X_{r,r}| \leq \epsilon \cdot r^3\}$. Note that this is a cylinder event, so we are allowed to use construction (1.4). The proof heavily relies on the result of Kozma and Nachmias [12] that for high dimensional percolation (that is, in models for which (1.3) holds):

$$\mathbb{P}_{p_c}(0 \leftrightarrow \partial Q) \asymp r^{-2}. \quad (6.1)$$

First we (re)state some definitions.

Definition 6.1

$$\begin{aligned} X_{r,R} &:= \left\{ x \in Q_r \mid 0 \stackrel{Q_R}{\leftrightarrow} x \right\} \\ \partial X_{r,R} &:= \left\{ x \in \partial Q_r \mid 0 \stackrel{Q_R}{\leftrightarrow} x \right\} \end{aligned}$$

and more generally, for any $A \subset \mathbb{Z}^d$ we write

$$\partial A := A \cap \partial Q_{(\max_{x \in A} |x|)}$$

and we define \bar{A} to be the set of edges that have both vertices in $Q_{(\max_{x \in A} |x|)}$, at least one of which is in A .

Proof of Theorem 1.16

Proof. For the moment, fix a vertex $x \in \mathbb{Z}^d$ with $|x| \geq 2r$. If $0 \leftrightarrow x$ and $|X_{r,r}| \leq \epsilon \cdot r^3$ then there must exist a (random) integer $j \in [r/2, r]$ such that $0 < |\partial X_{j,j}| \leq |\partial X_{j,r}| \leq 2\epsilon \cdot r^2$. Fix the smallest such j . We call $A \subset \mathbb{Z}^d$ *admissible* if $\mathbb{P}_{p_c}(X_{j,j} = A) > 0$. Here $\{X_{j,j} = A\}$ is an abbreviation for the event

$$\{X_{j,j} = A \text{ and } j \text{ is the minimal integer in } [r/2, r] \text{ such that } 0 < |\partial X_{j,j}| \leq 2\epsilon \cdot r^2\}.$$

Now write

$$\begin{aligned} \mathbb{P}_{p_c}(|X_{r,r}| \leq \epsilon r^3, 0 \leftrightarrow x) &= \sum_{A \text{ admissible}} \mathbb{P}_{p_c}(X_{j,j} = A, 0 \leftrightarrow x) \\ &= \sum_{A \text{ admissible}} \mathbb{P}_{p_c}(0 \leftrightarrow x \mid X_{j,j} = A) \cdot \mathbb{P}_{p_c}(X_{j,j} = A). \end{aligned} \quad (6.2)$$

We proceed by bounding $\mathbb{P}_{p_c}(0 \leftrightarrow x \mid X_{j,j} = A)$. If $0 \leftrightarrow x$ then there exists an $y \in \partial X_{j,j}$ such that y is connected to x “off $\bar{X}_{j,j}$ ”, that is: y is connected to x by an open path that does not use any of the edges in $\bar{X}_{j,j}$. So

$$\mathbb{P}_{p_c}(0 \leftrightarrow x \mid X_{j,j} = A) \leq \sum_{y \in \partial A} \mathbb{P}_{p_c}(y \leftrightarrow x \text{ off } \bar{A} \mid X_{j,j} = A). \quad (6.3)$$

Now: for all admissible A and all $y \in \partial A$ the event $\{y \leftrightarrow x \text{ off } \bar{A}\}$ only depends on the edges that are not in \bar{A} , while $\{X_{j,j} = A\}$ only depends on the edges that are in \bar{A} . Indeed, since A is admissible it already holds that j is the minimal integer in $[r/2, r]$ such that $|\partial Q_j \cap A| \leq 2\epsilon r^2$, so $\{X_{j,j} = A\}$ occurs iff

$$\left\{ \begin{array}{l} \text{All edges that have exactly one vertex in } A \text{ and both vertices in } Q_{(\max_{x \in A} |x|)} \text{ are closed and all vertices in } \\ A \text{ are connected to } 0 \text{ by a path consisting of open edges that all have both vertices in } A. \end{array} \right\}$$

occurs, which implies that $\{X_{j,j} = A\}$ only depends on the edges in \bar{A} , as illustrated in Figure 8. The consequence is that the events $\{X_{j,j} = A\}$ and $\{y \leftrightarrow x \text{ off } \bar{A}\}$ are *independent*. This observation

is the reason why this proof works for the set $X_{r,r}$ and not -for example- for X_r , because now it follows from (6.3) that

$$\mathbb{P}_{p_c}(0 \leftrightarrow x \mid X_{j,j} = A) \leq \sum_{y \in \partial A} \mathbb{P}_{p_c}(y \leftrightarrow x \text{ off } \bar{A}). \quad (6.4)$$

By the assumption on x we have $|x - y| \geq |x| - |y| \geq |x| - r \geq \frac{|x|}{2}$, so

$$\sum_{y \in \partial A} \mathbb{P}_{p_c}(y \leftrightarrow x \text{ off } \bar{A}) \leq \sum_{y \in \partial A} \mathbb{P}_{p_c}(y \leftrightarrow x) \leq \sum_{y \in \partial A} \frac{C}{|x - y|^{d-2}} \leq C \cdot |\partial A| \cdot \frac{1}{|x|^{d-2}}, \quad (6.5)$$

which is bounded above by $C \cdot 2\epsilon r^2 \cdot \frac{1}{|x|^{d-2}}$ because A is admissible. Combining this with (6.2) yields

$$\mathbb{P}_{p_c}(|X_{r,r}| \leq \epsilon r^3, 0 \leftrightarrow x) \leq C \cdot \epsilon r^2 \cdot \frac{1}{|x|^{d-2}} \cdot \sum_{A \text{ admissible}} \mathbb{P}_{p_c}(X_{j,j} = A). \quad (6.6)$$

Now note that the events $\{X_{j,j} = A_1\}, \{X_{j,j} = A_2\}, \dots$ are disjoint and the union of these over all A implies that $0 \leftrightarrow \partial Q_{r/2}$, so by (6.1):

$$\sum_{A \text{ admissible}} \mathbb{P}_{p_c}(X_{j,j} = A) \leq \mathbb{P}_{p_c}(0 \leftrightarrow \partial Q_{r/2}) \leq C \cdot r^{-2}. \quad (6.7)$$

Evaluating (6.7) in (6.6) and using construction (1.4) of the IIC-measure we finally obtain

$$\mathbb{P}_{IIC}(|X_{r,r}| \leq \epsilon \cdot r^3) = \lim_{|x| \rightarrow \infty} \frac{\mathbb{P}_{p_c}(|X_{r,r}| \leq \epsilon r^3, 0 \leftrightarrow x)}{\mathbb{P}_{p_c}(0 \leftrightarrow x)} \leq C \cdot \lim_{|x| \rightarrow \infty} \left(\frac{\epsilon \cdot |x|^{2-d}}{|x|^{2-d}} \right) = C \cdot \epsilon,$$

where the constant $C > 0$ is independent of ϵ and r . Now apply Theorem 1.10 and use the fact that $|X_{r,r}| \leq |X_r|$ for all r to conclude that

$$\mathbb{P}_{IIC}(\underline{d}_m(IIC) \geq 3) := \mathbb{P}_{IIC} \left(\liminf_{r \rightarrow \infty} \left(\frac{\log |X_r|}{\log r} \right) \geq 3 \right) \geq \mathbb{P}_{IIC} \left(\liminf_{r \rightarrow \infty} \left(\frac{\log |X_{r,r}|}{\log r} \right) \geq 3 \right) = 1.$$

□

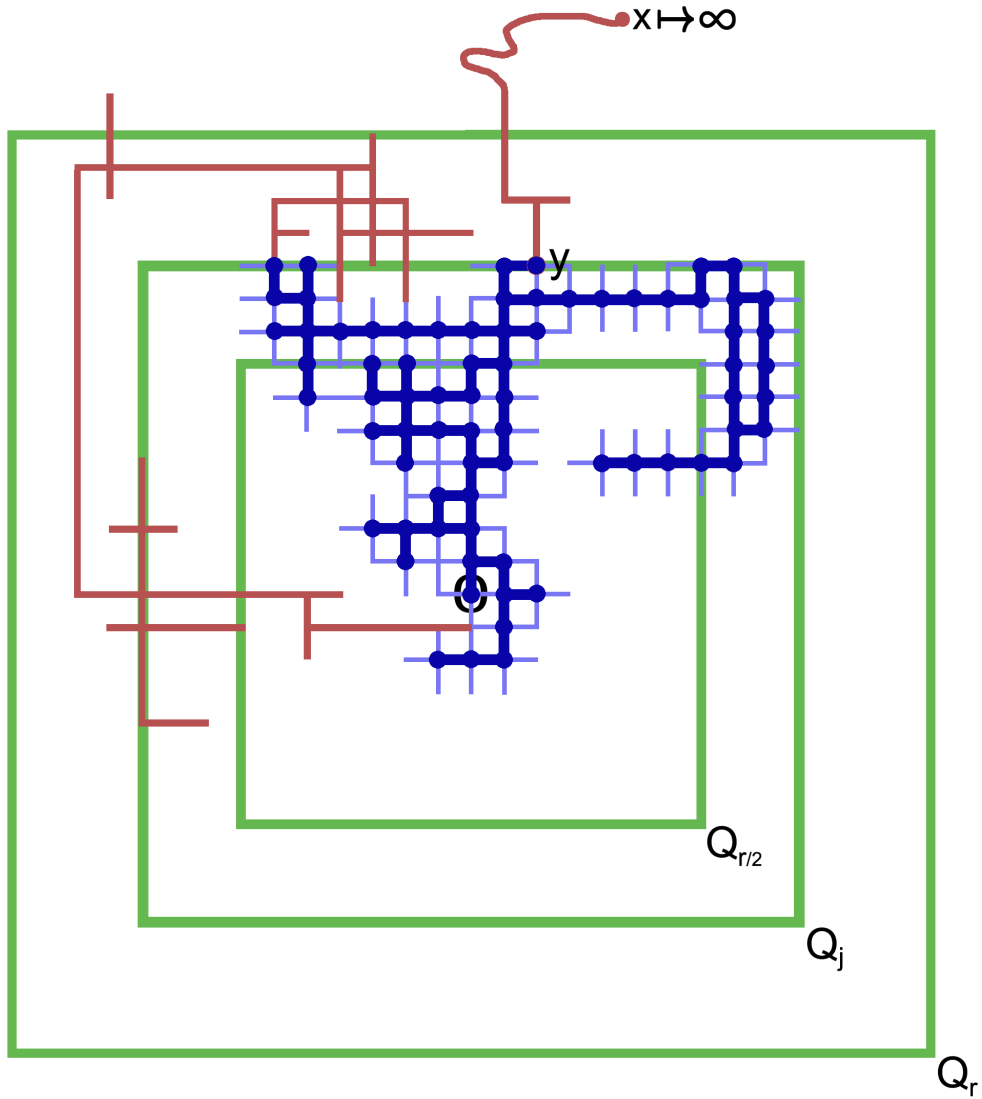

Figure 8: This picture illustrates the proof of Theorem 1.16. This is an ‘artist impression’, not a simulation. Note also that in reality we consider high dimensional percolation, not 2-dimensional percolation. The vertices that are adjacent to fat blue edges form the vertex set $X_{j,j} = A$. The fat blue and the thin blue edges together form the edge set \bar{A} . The fat blue and the red edges together form the IIC. The symbol 0 denotes the origin and y denotes one of the 6 vertices in $\partial A \subset \partial Q_j$. The green lines denote the boundaries of $Q_{r/2}$, Q_j and Q_r .

References

- [1] G. Grimmett. Percolation, Second Edition. *Springer*, (1999).
- [2] M. Heydenreich, R. v.d. Hofstad and T. Hulshof. High-dimensional incipient infinite clusters revisited. *submitted*.
- [3] G. Grimmett. Probability on Graphs. *Cambridge University Press*, (2010).
- [4] M. Aizenman and D. Barsky. Sharpness of the phase transition in percolation models. *Commun.Math.Phys.*, **108**:489-526, (1987).
- [5] T. Hara and G. Slade. Mean-field behaviour and the lace expansion. In G. Grimmet, editor, *Probability and Phase Transition*, Dordrecht, KLuwer, (1994).
- [6] R. Fitzner. Non-backtracking lace expansion. The NoBLE project. PhD thesis, *TU Eindhoven*, (2013).
- [7] T. Hara and G. Slade. Mean-field critical behaviour for percolation in high dimensions. *Commun. Math. Phys.*, **128**:333-391, (1990).
- [8] T. Hara, R. v.d. Hofstad and G. Slade. Critical two-point functions and the lace expansion for spread-out high-dimensional percolation and related models. *Ann.Probab.*, **31**(1):349-408, (2003).
- [9] T. Hara. Decay of correlations in nearest-neighbour self-avoiding walk, percolation, lattice trees and animals. *Ann.Probab.*, **36**(2):530-593, (2008).
- [10] M. Aizenman On the number of incipient spanning clusters. *Nucl.Phys. B*, **485**:551-582, (1997).
- [11] R. v.d. Hofstad and A. Járai. The incipient infinite cluster for high-dimensional unoriented percolation. *J.Statist.Phys.*, **114**(3-4):625-663, (2004).
- [12] G. Kozma and A. Nachmias. Arm exponents in high-dimensional percolation. *J.Amer.Math.Soc.*, **24**:375-409, (2011).
- [13] G. Kozma and A. Nachmias. The Alexander-Orbach conjecture holds in high dimension. *Invent.Math.*, **178**:635-654, (2009).
- [14] P. Mörters and Y. Peres. Brownian motion. *Cambridge University Press*. (2010).
- [15] D. Dawson and E. Perkins. Measure-valued processes and renormalization of branching particle systems. Stochastic Partial Differential Equations: Six Perspectives (edited by R. Carmona and B. Rozovskii). *AMS Math. Surveys and Monographs*. (1997).
- [16] M. Heydenreich, R. v.d. Hofstad, T. Hulshof and G. Miermont. Backbone scaling limit of the high-dimensional IIC. *In preparation*.
- [17] G.R. Grimmett and D.R. Stirzaker. Probability and Random Processes. Second edition. *Oxford Science Publications*, (1992).
- [18] M. Talagrand. On Russo's approximate zero-one law. *Ann.Probab.* **22**(3):1576-1587, (1994).
- [19] B.T. Graham and G.R. Grimmett. Influence and sharp-threshold theorems for monotonic measures. *Ann.Probab.*, **34**(5):1726-1745, (2006).
- [20] T. Hara and G. Slade. The incipient infinite cluster in high-dimensional percolation. *Electron. Res. Announc. Amer. Math. Soc.*, **4**:48-55, (1998).
- [21] T. Hara and G. Slade. The scaling limit of the incipient infinite cluster in high-dimensional percolation. I. Critical exponents. *J.Stat.Phys.*, **99**:1075-1168, (2000).
- [22] T. Hara and G. Slade. The scaling limit of the incipient infinite cluster in high-dimensional percolation. II. Integrated super-Brownian excursion. *J.Stat.Phys.*, **41**:1244-1293, (2000).

- [23] T.Hara, R. v.d. Hofstad and G. Slade. Critical two-point functions and the lace expansion for spread-out high-dimensional percolation and related models. *Ann. Probab.*, **31**(1):349-408, (2003).
- [24] F. Hausdorff. Dimension und äußeres Maß. *Mathematische Annalen*. **79**:157-179, (1919).
- [25] C. Bandt and H. Haase, Die Wirkungen von Hausdorffs Arbeit über Dimension und äußeres Maß, in *Felix Hausdorff zum Gedächtnis. Braunschweig*. **I**:149-183. (1996).
- [26] M. T. Barlow and S. J. Taylor. Fractional dimension of sets in discrete spaces. *J.Phys. A: Math. Gen.* **22**:2621-2626, (1988).